



Design & New

Kitchen & Furniture Accessory Collection





CREATIVE
GLOBAL LEADER

D & NEW
KITCHEN SYSTEM & FURNITURE



P h i l o s o p h y

Best Happiness and Joy
in your life and business

GREETING

Dear Customers,

Thank you for your interest in our company. We are happy to introduce D&NEW Co., Ltd., a leading manufacturer of household furniture accessories. We specialize in designing and manufacturing a variety of household hardware accessories associated with kitchen furniture, general furniture, office furniture, and architectural interior design. We also continue to expand our presence and the scope of our product portfolio to include various accessories for smart portable devices. We retain advanced professional designing and manufacturing capabilities along with the extensive knowledge and experience of customer-oriented sales and marketing. For us, customer satisfaction is regarded as our top priority. We always give our best effort to improve the dignity of furniture culture and life style as well as customer satisfaction by producing smart quality products equipped with outstanding design, functionality and ease of use. We aim for all of our products to be perfectly aligned with customers' circulations at home and create interior designs with a delicate touch down to the smallest details. We are committed to sustaining our growth as a trusted partner of our customers and fulfilling our corporate social responsibilities all while putting in are lentless effort to develop and deliver new innovative products and to enhance competitiveness at home and abroad. Our mission is to bring happiness and joy to our customers in their everyday life and their business as well.

I would like to kindly ask for your continued interest and encouragement.
Thank you.

D&NEW Co., Ltd.
CEO, Park Pil-seo



01

Kitchen Furniture

Page 6-93

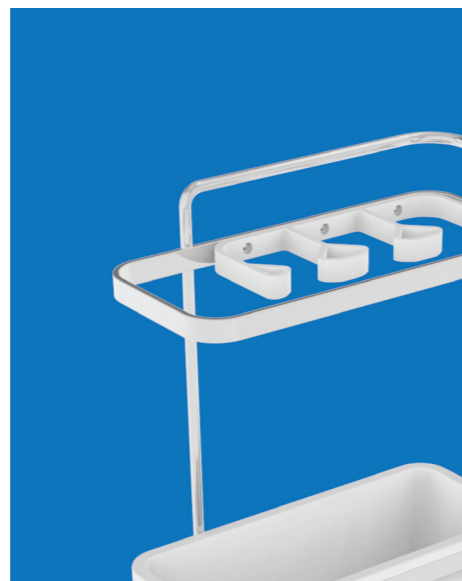

02

General Furniture

Page 94-141

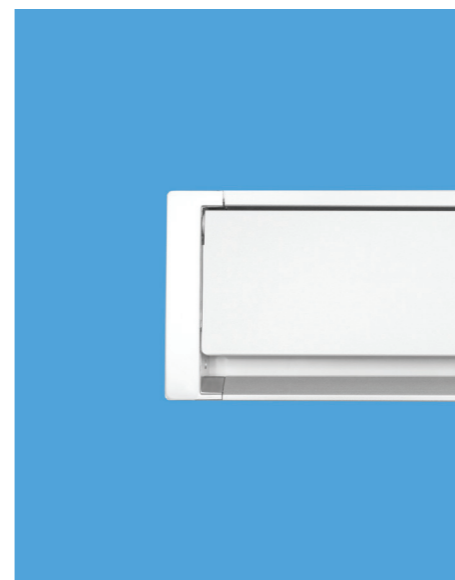

03

Office Furniture

Page 142-153

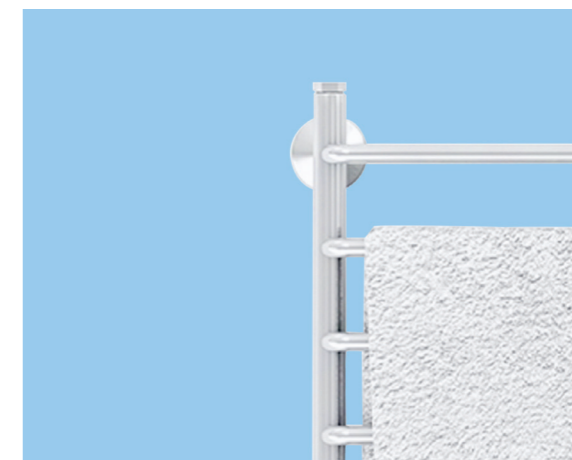

04

Bathroom Furniture

Page 154-157

Kitchen Furniture



Upper Cabinet

Hanger ACC	8–20
Profile	21
Lighting	22–25
Storage Hardware	26–33
Misc.	34–35

Counter Cabinet

Spice Rack	36–43
Injection Rack	44–45
Pull-out Hardware	46–57
Spoon Separator	58–63
Drawer Hardware	64–65
Knife Holder	66–67
Outlet	68–69
Injection Garbage Bin	70–71
Storage Hardware	72–77
Misc.	78–93



NS ACC (3 items)

Applicable to lighting and profile. With the adoption of an aluminum panel along with the square type frame, they feature the stylish and clean impression of the metallic design as well as the solid and stable image of the metallic material, creating a chic and sophisticated atmosphere. Bright silver and dark brown are completed by the kitchen furniture colors, which enhances the overall elegance of your kitchen.

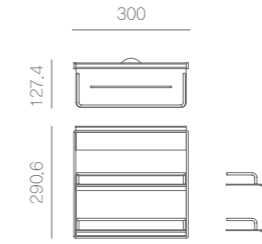

Double layer shelf / D1-ANS-2

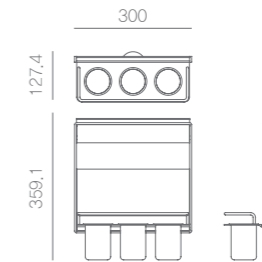

3-Cup Spoon Container / D1-ANS-S3

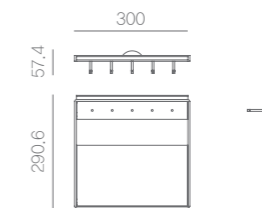

Versatile Hook / D1-ANS-D



Clear ACC (4 items)

The product features a high-gloss finish with a sophisticated and modern image comparable to that of kitchen furniture. The clean and pure feeling expressed by the white color enhances consumer satisfaction while the minimalist design makes them a good match with a variety of kitchen options of your choice. Plastic and aluminum prevent the products from corrosion featuring a streamlined and slim design, the product has an integral structure with no fitting or joint marks. They are applicable to lighting and profile. Made of aluminum, they are rust-free with the ease and convenience of changing the finished color to harmonize with your kitchen.

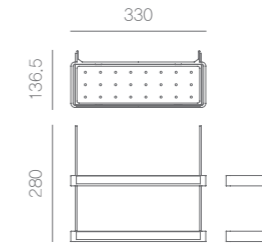

Double layer shelf / D1-ACL-2

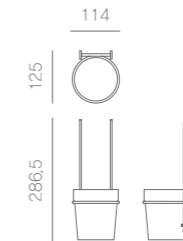

1-Cup Spoon Container / D1-ACL-S1

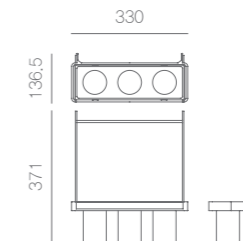

3-Cup Spoon Container / D1-ACL-S3

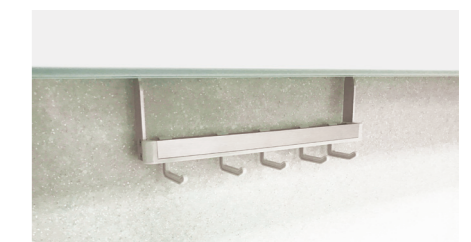
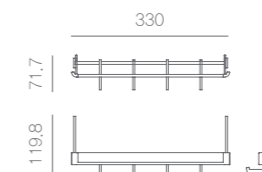

Versatile Hook / D1-ACL-D4



Pony ACC (4 items)

They feature a T-type design with a rectangular back panel that fastens the profile. In addition, square holes as an emphasis deliver a concise yet modern visual effect. These can be applied to lighting and profile. Made of aluminum, they are anti-corrosive and the soft, light colors match the kitchen door. Applicable to lighting and profile.

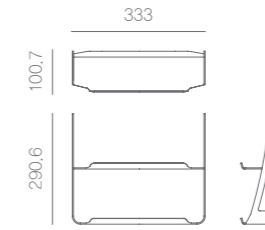

Double layer shelf / D1-APO-2

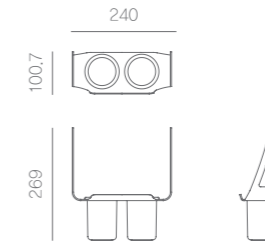

2-Cup Spoon Container / D1-APO-S2

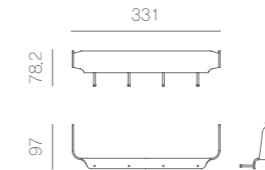

Versatile Hook / D1-APO-D5

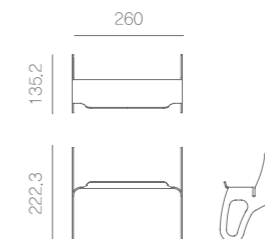

Kitchen Towel Hook / D1-APO-L



TMax ACC (3 items)

With the adoption of an aluminum panel along with the square type frame, they feature the stylish and clean impression of the metallic design as well as the solid and stable image of the metallic material, creating a chic and sophisticated atmosphere. Bright silver and dark brown are completed by the kitchen furniture colors, which enhances the overall elegance of your kitchen. Applicable to lighting and profile.

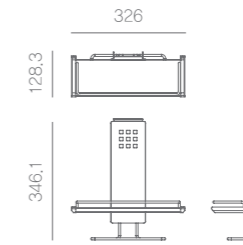

Single Layer Shelf / D1-ATM-1

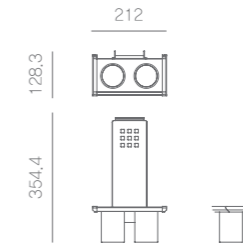

2-Cup Spoon Container / D1-ATM-S

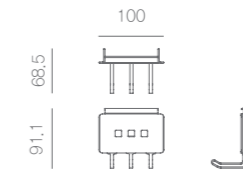

Versatile Hook / D1-ATM-D

New Vesta ACC (6 items)

The product features a high-gloss finish with a sophisticated and modern image comparable to that of kitchen furniture. The clean and pure feeling expressed by the white color enhances consumer satisfaction while the minimalist design makes them a good match with a variety of kitchen options of your choice.



Double layer shelf / D1-ABE-2JMM

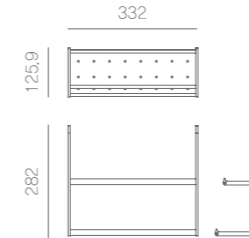

3-Cup Spoon Container / D1-ABE-JMMS3

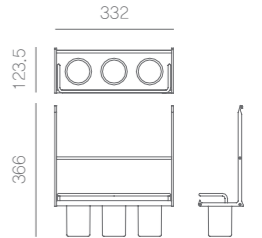

1-Cup Spoon Container / D1-ABE-JMMS1

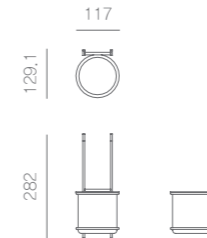

Versatile Hook / D1-ABE-JMMD5

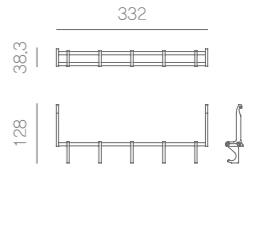

Dish Holder / D1-ABE-JMMJ

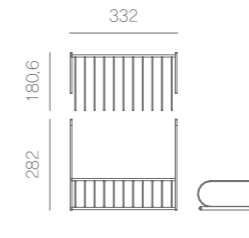

Kitchen Towel Hook / D1-ABE-JMML

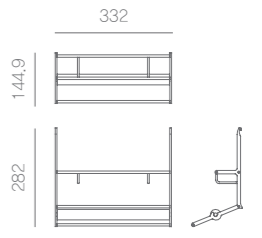

Smog ACC (3 items)

The silver colored square border and glossy acrylic black panel enhances the quality of the product expressing a modern and metallic touch. These can be applied to lighting and profile, and, in particular, feature a superb black-and-white harmony with a high-glossy white, which makes them perfect for decorating your kitchen in style.

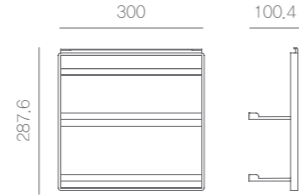

Double layer shelf / D1-ASM-2

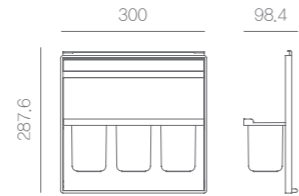

3-Cup Spoon Container / D1-ASM-S3

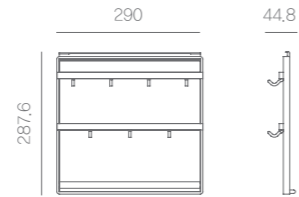

Versatile Hook / D1-ASM-D

Popular Wire ACC (3 items)

These are steady selling items that have long been popularly chosen by many housewives as well as by LH Corporation and in public apartment complex as kitchen accessories. They feature a robust and simple design with excellent quality and performance at competitive prices. They are detachable from the firmly fixed stainless hanger for easy cleaning and relocation.



Double layer shelf / D1-A2D



Kitchen Cloth Hanger / D1-GJHJ-H



1-Cup Spoon Container / D2-AST-S

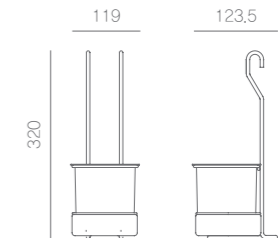
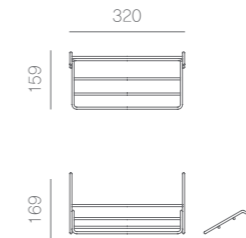
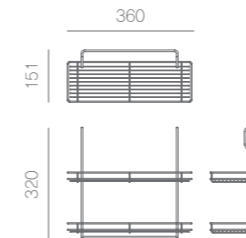

Rich Dish Rack

This is an all-in-one product that combines a double layer shelf, dish rack, and spoon container and is ideal for small space kitchens, studio apartment or single-person households. Our product design has gone beyond the traditional square shape and has instead created a semicircular curve by bending the wire. Its softer appearance combined with a ceramic spoon container provides you with visual comfort.

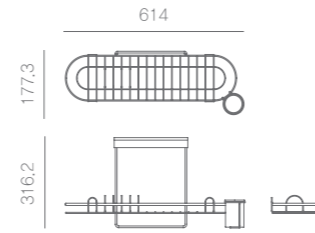

D1-DWD
600 Compatible



Profile



The profile is designed to support and suspend various accessories and is equipped with a safety function to prevent accessories from easily being detached and damaged. It also features a strong and rigid build to withstand the heavy load of multiple accessories.



Hanger Rod / D1-HHB-1000
1000 Compatible

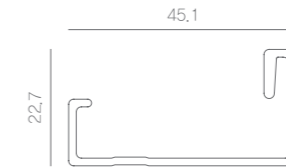

Vesta Profile / D1-HBE-1000
1000 Compatible

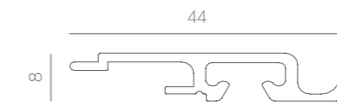

Smog Profile / D1-HSM-1000
1000 Compatible



Lighting



Pony Lighting Equipment
D1-LPO-1000TC
1000 Compatible
LED / T5



Light Glow Lighting Equipment
D1-LNA-1000TC
1000 Compatible
LED / T5



Change Lighting Equipment
D1-LCH-1000TC
1000 Compatible
LED / T5



Whale Lighting Equipment
D1-LWE-1000TS
1000 Compatible
LED / T5



Slim Lighting Equipment
D1-LSL-1000TC
1000 Compatible
LED / T5

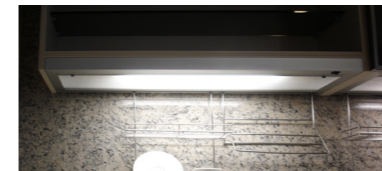

Fingerboard Lighting Equipment
D1-LJJ-1000LIB
1000 Compatible
LED / T5

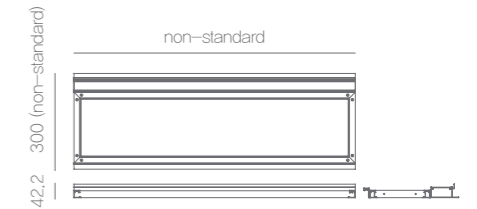

LED BAR
D2-LML-1000L



Dresser Lighting Equipment
D1-LHJ
LED

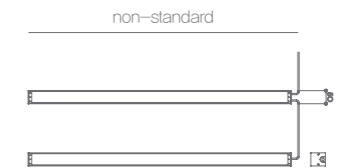



Clear Lighting Equipment

Our LED lighting that comes in white goes well with any furniture. It features a slim and neat design and the price is reasonable. The touch-based light-emitting switch adds an extra touch of sophistication to the product.



D1-LCL-1000
1000 Compatible
LED / T5





Smart Mount

This product can be easily mounted on any kitchen furniture and is designed to facilitate searching for everyday life information or media reports while engaging in cooking. It also comes in a foldable structure for storage when not in use and is equipped with a timer function for extra user convenience. In addition, it has been developed to run on batteries to make it easy to relocate and mount on various items such as bookcases and dressers.

- ○

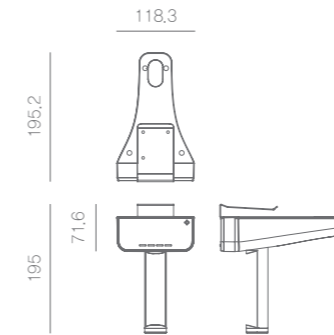

D1-GJIP



Folded



Unfolded



Smart Pad Mount



Loony Kitchen Cloth Hanger

It is designed to be attached under the kitchen top shelf and comes with an up-down function to elevate dishcloths so that they are not fully visible in front view. You may also hang rubber gloves as well as dishcloths for more efficient utilization of kitchen space in a hygienic manner.

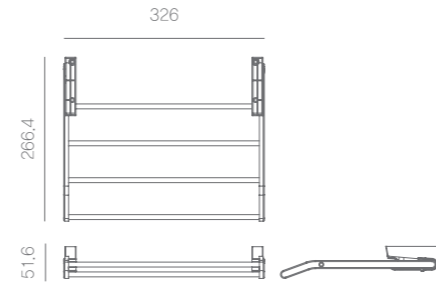

D2-GJLN



Pot Lid Rack

When you need to take a look at the progress of your cooking or open the lid, you usually place the lid on the top plate. This, however, is not only unsanitary but also visually unappealing. The cover rack comes into play for just these occasions and allows you to hygienically mount the kitchen utensil lids for pots. You can also hang dishcloths and rubber gloves when not cooking. This product is designed to maximize practical use and the price is reasonable.

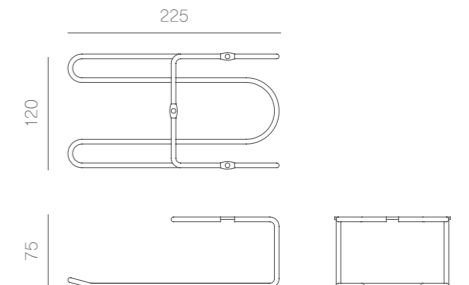

D1-GJJN



Can Holder

Designed to be installed on the back of the sink door, this product is designed to store a variety of kitchen utensils. It comes in either fabric type or wire type and also in three different sizes, including 400, 500, and 600.



Screw type / D1-BCA-400P



Screw type (fabric) / D1-BCA-400PP

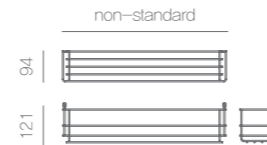
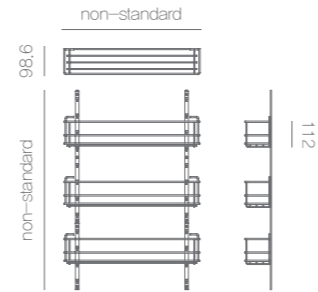

Shelf support type / D1-BCA-400D



Shelf support type (fabric)/ D1-BCA-400DP

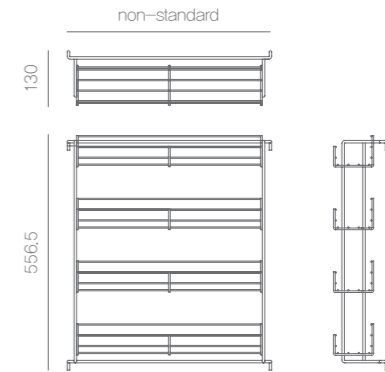

Rotating Can Holder
D1-BCA-400H

Kitchen Shelf



Slim Basket / D1-BSL-500



Cube Round Shelf / D1-PQU-800

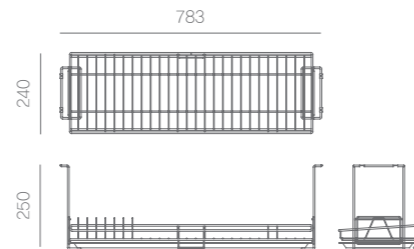

Suspension Dish Holder / D2-DSG-800

Island Shelf

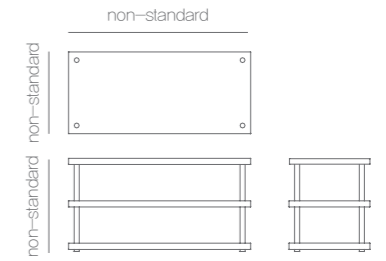

Wood / D1-PCI-T1000

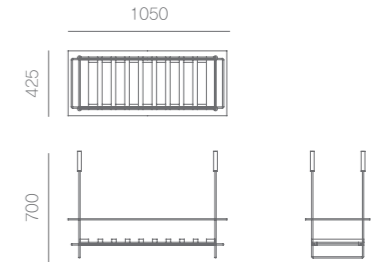

Hardwood / D1-PCI-W1000

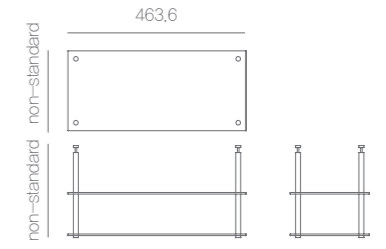

Glass / D1-PCI-G1000

Wine Glass Rack



D1-GJWG-400

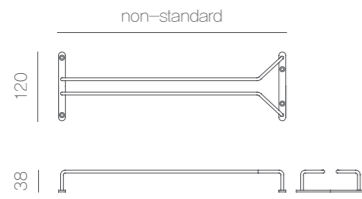

Stainless Door



D1-GJSD-BG
* Maximum size: W 600mm

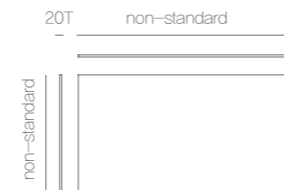

Long Push Button

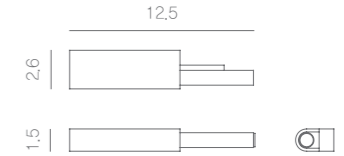

D1-GIPR

Switch Box Cover

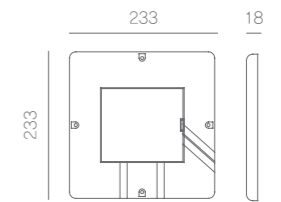

Large / D1-KBC-10N

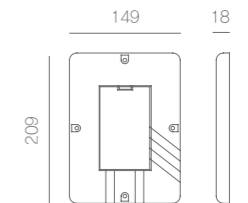

Small / D1-KBC-20N

Sweetie Spice Rack

It comes with rails on both sides of the product, unlike conventional extractable storage racks, to be able to withstand excessive loads. The frames both on the left and right serve as the guide bars to prevent long spice jars from falling over. It is also equipped with an allpurpose hook on the front of the lower section to keep kitchen utensils. The products are compatible with the standard door sizes 150/200/250/300 and non-standard customized products will be available upon request.

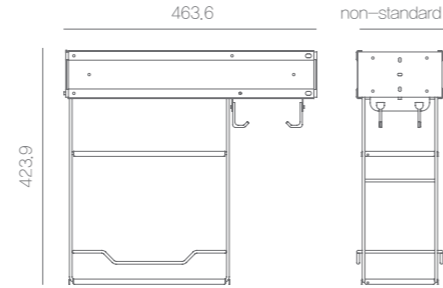

- D1-YSW-150 / 150 Compatible
- D1-YSW-200 / 200 Compatible
- D1-YSW-250 / 250 Compatible
- D1-YSW-300 / 300 Compatible

Max Spice Rack

It comes in a sleek design with damping rails. It features a portable basket on top and versatile hooks for extra user convenience. It has also a divider in the basket to prevent long spice jars from falling over. The basket made of aluminum is also damage-free when removing stains such as oil dirt. The products are compatible with the standard door sizes 150/200.

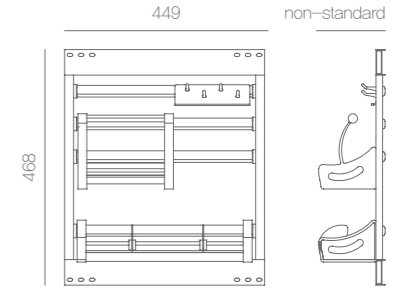

- D1-YTM-150 / 150 Compatible
- D1-YTM-200 / 200 Compatible



Spicy Spice Rack

This product features a strong damping frame and sleek aluminum basket to create a modern image with the height of the upper and lower baskets adjustable for convenience purposes. It is equipped with a leaf-shaped divider to facilitate the storage. The products are compatible with the standard door sizes 150/200/250/300.

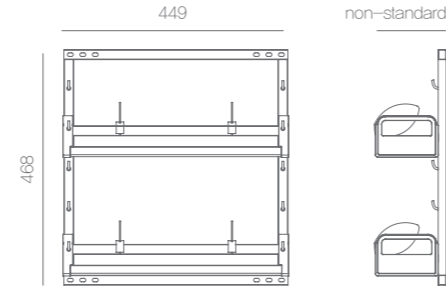

- D1-YSP-150 / 150 Compatible
- D1-YSP-200 / 200 Compatible
- D1-YSP-250 / 250 Compatible
- D1-YSP-300 / 300 Compatible



Lime Spice Rack

The front of the extractable storage rack is made of a stainless steel glossy panel for a luxurious and sophisticated image. Multiple bracket holes are used for height adjustment to make the front panel look neat and modern. The leaf-shaped divider and versatile hooks have improved functionalities. The products are compatible with the standard door sizes 150/200/250/300.

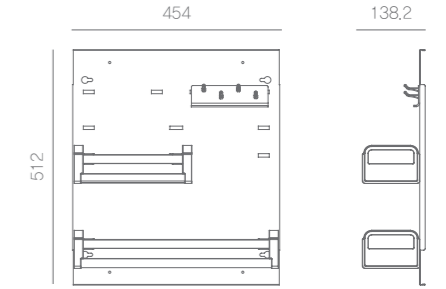

- D1-YLM-150 / 150 Compatible
- D1-YLM-200 / 200 Compatible
- D1-YLM-250 / 250 Compatible
- D1-YLM-300 / 300 Compatible



Popular Spice Rack

D1-YSL-150D / 150 Compatible
D1-YSL-200D / 200 Compatible
D1-YSL-300D / 300 Compatible

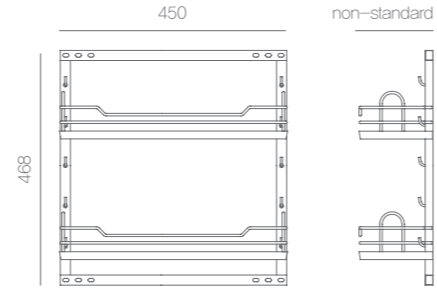

Square Spice Rack

D1-YSK-200 / 200 Compatible
D1-YSK-250 / 250 Compatible

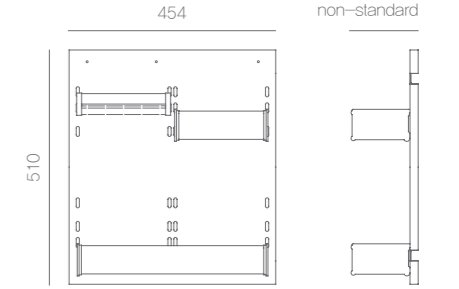

Combi-Spice Rack

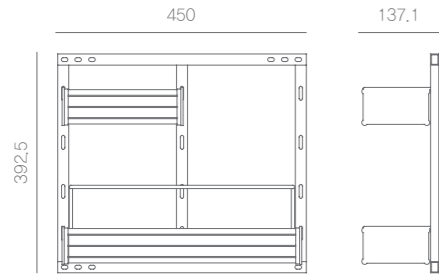

D1-PLJC-150 / 150 Compatible
 D1-PLJC-200 / 200 Compatible
 D1-PLJC-300 / 300 Compatible



Cube Spice Rack

The product is mainly installed in the lower kitchen rack. These come as extractable types and are convenient to keep a variety of spice jars. They are particularly ideal for those who suffer backache as they can remove spice jars by pulling the basket handle upward. You may install one of these in tight spaces hampered by sink bowls to maximize space utilization.

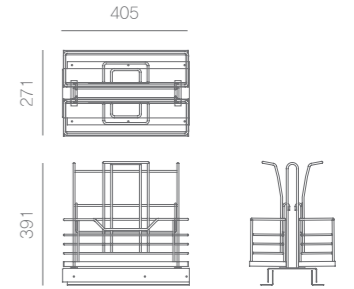

D1-YQU



Combi Injection Drawer Rack

Drawer Included / D1-PLCB-150 / 150 Compatible
 Drawer Included / D1-PLCB-200 / 200 Compatible
 Drawer Included / D1-PLCB-300 / 300 Compatible

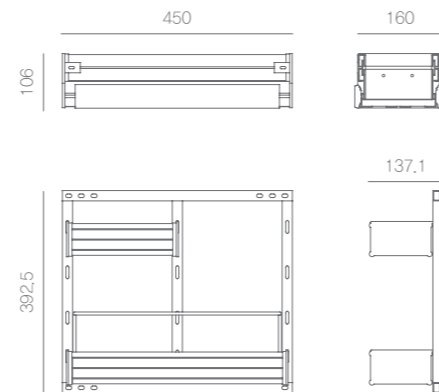

Tall Injection Rack

The tall extractable storage rack is designed to maximize storage efficiency in a small area and to allow users to view practically all storage items at a single glance. It is equipped with a robust frame and damping function with the height of the baskets adjustable for convenience and ease of use. The biggest advantage of this product is that it can keep many kitchen utensils in a limited space.

D1-YKI-200 / 200 Compatible
 D1-YKI-250 / 250 Compatible
 D1-YKI-300 / 300 Compatible

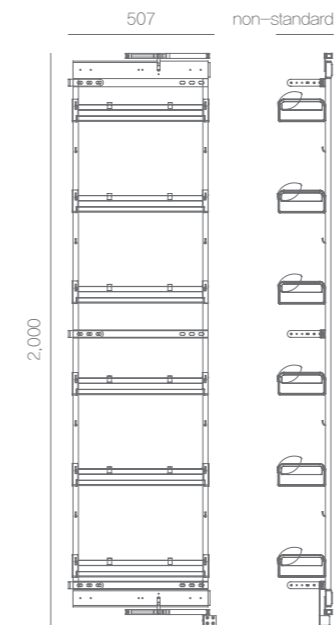



Cuzy Pan Drawer

This is dedicated to storing frying pans only. It comes in an all-in-one strong build die cast design. You may have frying pan handles rest in the basket groove to minimize the noise when opening and closing the drawer. It is also equipped with a side basket to maximize space utilization. This product enhances the utilization of the empty space inside the rack base of the kitchen bottom. It is a functional hardware product that improves the space efficiency by utilizing the empty space on the inside of rack rest of the lower kitchen rack and placing frequently used pans in a dedicated drawer.



15T: W554
18T: W548

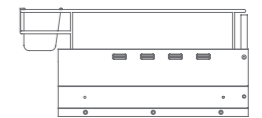
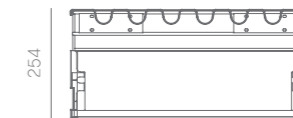
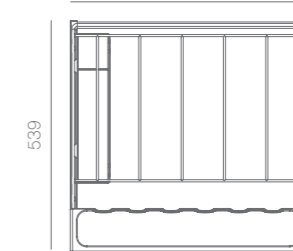

D1-SCU / 600 Compatible



Dual Pan Drawer

This is a pan drawer installed under the sink. Made of stainless steel wire, it features corrosion-free sanitation and can be used to accommodate pot lids as well. It is designed to maximize the use of limited space and to allow you to store as many items as possible.

388 (including the rail)

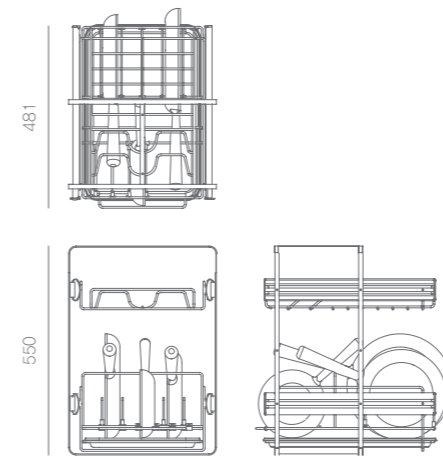

D1-SDP / non-standard



Reform Recycling Bin

In line with a strong drive for recycling and reusing all household wastes and byproducts in accordance with legal and administrative recommendations, this product is designed to facilitate the separate collection of household wastes for recycling purposes. It comes in both door-mounted and open-end type with an easily available attachable plastic bag storage unit and/or a semi-permanent tarpaulin plastic bag storage unit, which can also be used as laundry storage.



Door Type / D1-SRB-D500
 500 Compatible
 (Non-standard Production Available)

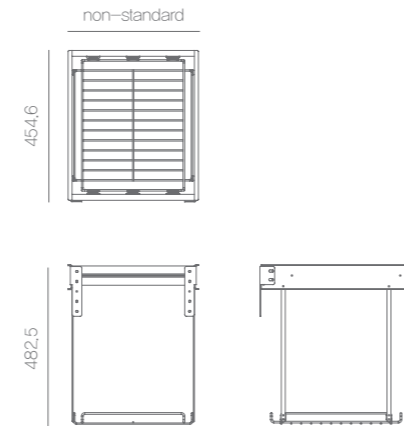

Open-End Type / D1-SRB-O500
 500 Compatible
 (Non-standard Production Available)

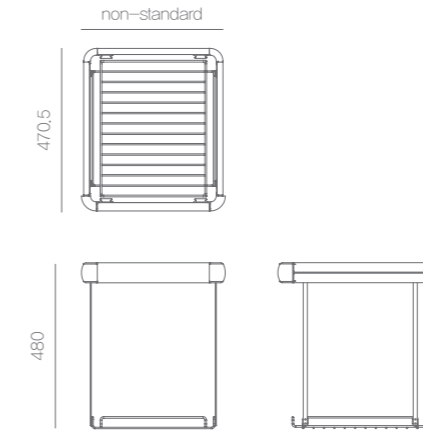

Meredae Laundry Drying Rack

This is a drawer-type laundry drying rack designed to maximize space utilization. It is normally built inside the drawer and is unfolded wide on both sides. Sturdy three-stage damping rails and stainless steel rods enable users to hang a large number of clothing items in a limited space. It is ideal for small and medium-sized apartments and/or studio apartment with space restraints.

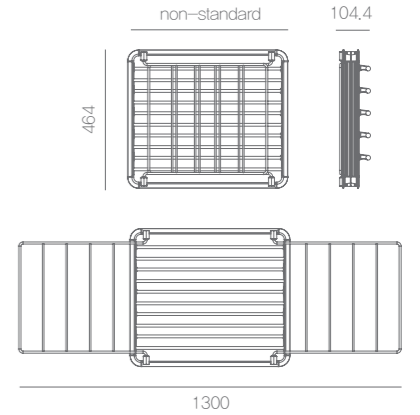

D1-GIMD-600 / 600 Compatible
 * Internal height: should be at least 135mm



Injection Drawer



1 Layer Injection Drawer / D1-SIS-400
400 Compatible

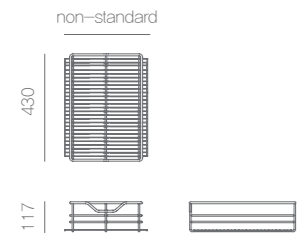

2 Layer Injection Drawer / D1-SIS-400-2
400 Compatible

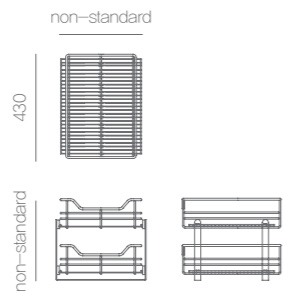

Laundry Basket



Board Type / D1-TBO

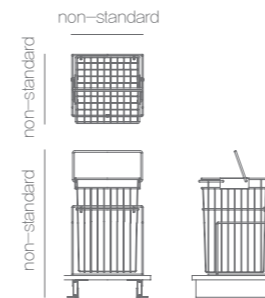

Injection Type / D1-TIN



Flap Type / D1-TPL

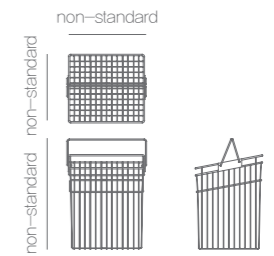

Injection Cutting Board Tray Holder

This is an extractable storage rack that can store a variety of cutting boards and trays in a hygienic manner. Keeping cutting boards and trays in different sizes that otherwise occupy a significant amount of kitchen top space in this rack will make your kitchen neat and more convenient.



Board type
D1-YID-P

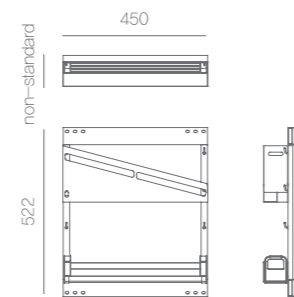

Wire type
D1-YID-W

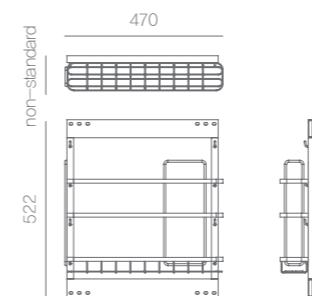

AL Baseboard Drawer



D1-SGB-600 / 600 Compatible

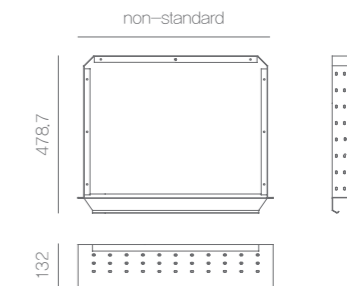

Deluxe Spoon Separator

The product features aluminum as its finishing material, which is hygienic, lightweight and easy to maintain. The product is comprised of an injection knife holder, rest, divider and an aluminum body. Non-standard products are available upon request. A safety cover designed to enhance hygiene and safety is available as an option.



D1-SDI-800D
800 Compatible
(Non-standard Production Available)



PVC Spoon Separator

The spoon separator made of plastic material comes in various shapes and sizes along with an optional divider available to choose from. The affordable price and hygienic material make it one of the most popular commodities.

D1-SSB-600

600 Compatible

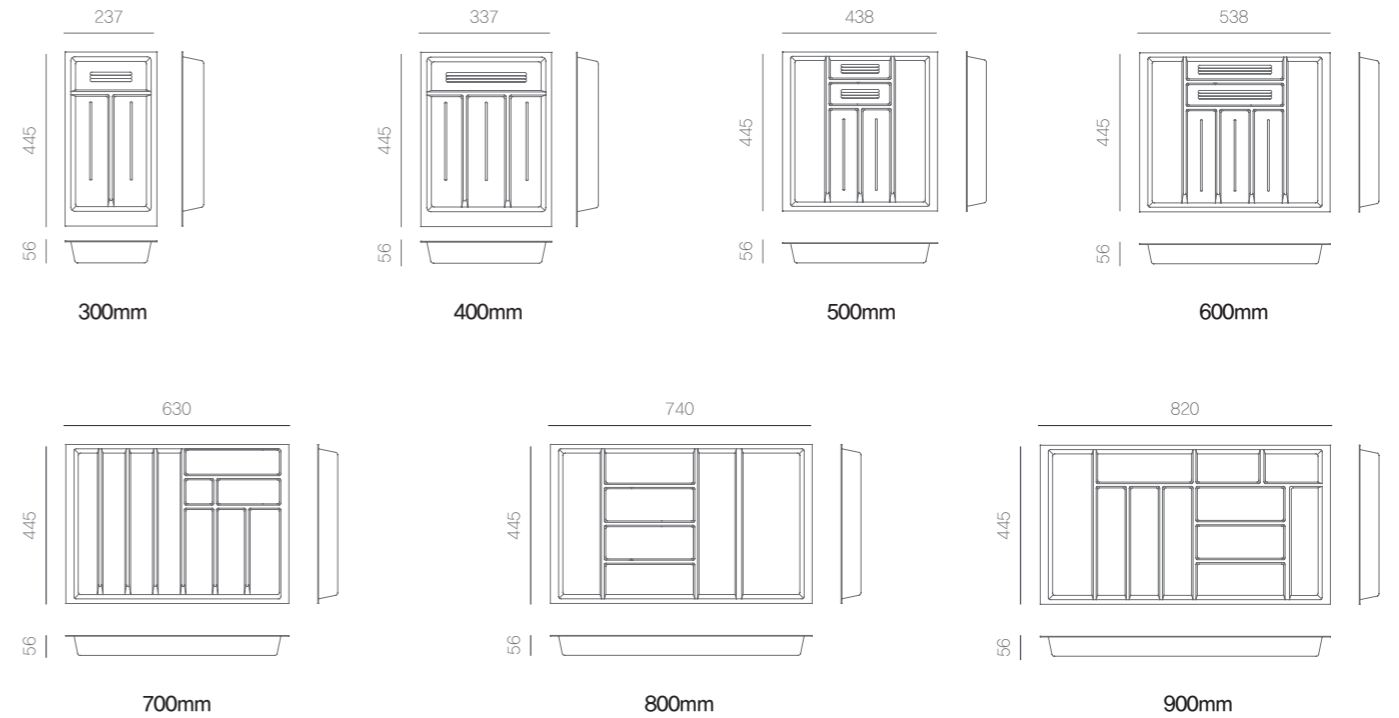

AL Spoon Separator

Finished with aluminum, this product offers a sleek design. It is also sanitary and light with easy maintenance. The product is comprised of a wood knife rest, divider, and the aluminum body. This product can be customized in non-standardized sizes to meet your specific needs.

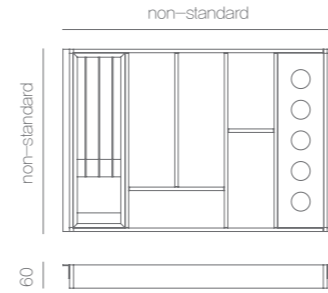

D1-SAS-800D
 800 Compatible
 (Non-standard Production Available)



Other Spoon Separators

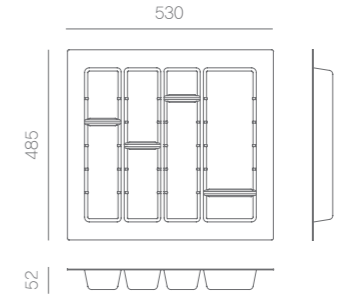

Divider Spoon Separator / D1-SSB-600D
 500, 600, 700, 800 Compatible

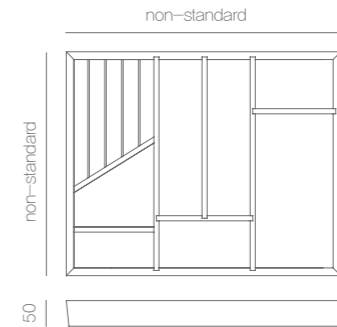

Wooden Spoon Separator / D1-SYS-800
 800 Compatible (Non-standard Production Available)

AL Divider

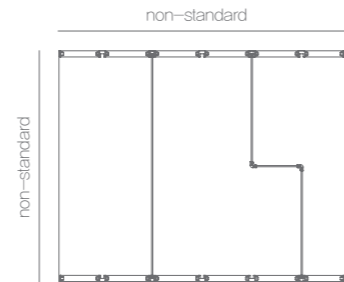

D1-SAD-600
600 Compatible
(Non-standard Production Available)

Drawer Spice Jar Basket

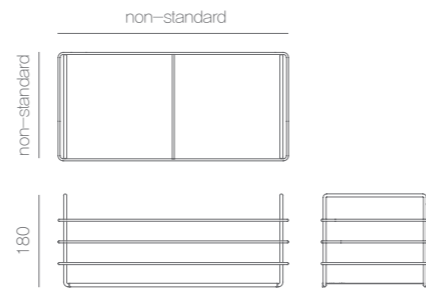

D1-SYB-600
600 Compatible
(Non-standard Production Available)

Dish Holder Mat

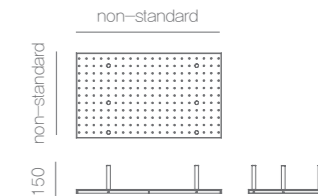

AL, Stainless / D1-SJM-600
600 Compatible
(Non-standard Production Available)

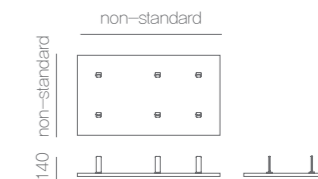

Magnetic Mat / D1-SMM-600
600 Compatible
(Non-standard Production Available)

Non-slip Mat

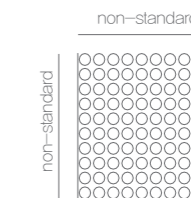
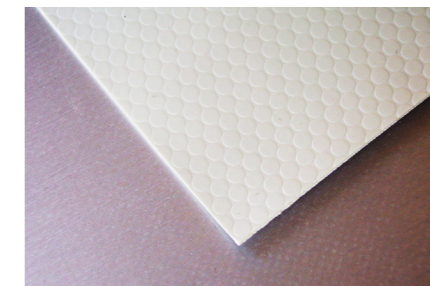

D1-GJNS-600
Non-standard Production Available

Deluxe Knife Holder

Attached to the inner side of the door, it can accommodate several kitchen knives. The safety lock on top is designed to prevent any possible accidents. In addition to the storage of knives, it is also equipped with a dish cloth hanger, which is used as the handle as well for extra convenience and space utilization.

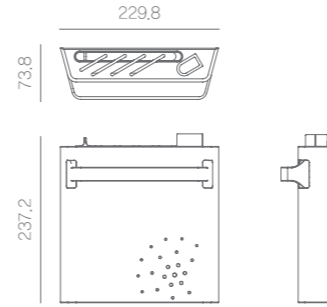

D1-NDS



Double Layer Knife Holder



D1-K2D

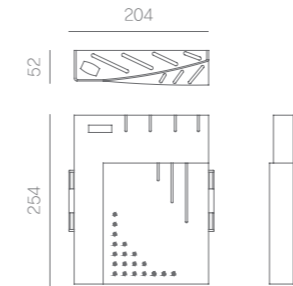

Clear Knife Holder



D1-KCL

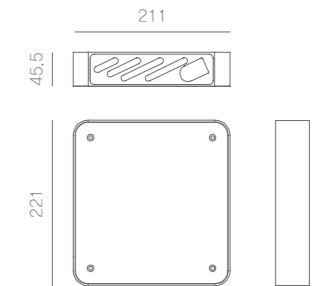

Popping Outlet

It is installed upon a hole on the counter and automatically pops out upon pressing the cover. It is designed to be water resistant when the cover is closed. It comes in silver and black nickel color depending on your kitchen furniture finish and boasts a luxurious looking aluminum top cover. It is also detachable for easy after-sales maintenance. It is suitable for an island kitchen where it is difficult to install the cover outlet.

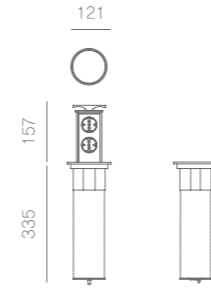

D1-CJA-C2 / 2 Sockets
Size of die cutting on top board: 105mm



Slim Outlet

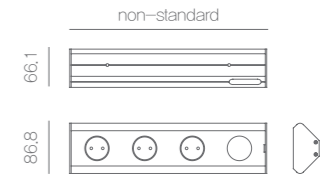

D1-CSL
The Number of outlets:
1 - 4 outlets
available

Easy Outlet

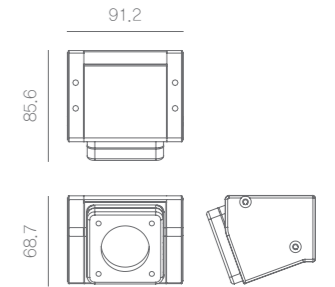

D1-CEG-C
1 and 2 outlets available
(W: 156mm)

Injection Garbage Bin

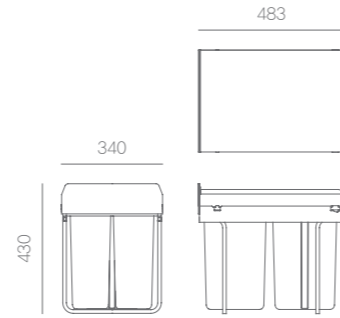

Injection Type / D1-GGST-I



This built-in garbage bin is designed to be installed on a dressing table or vanity cabinet. It is composed of a top cover and a basket on the bottom as a set for convenient use.

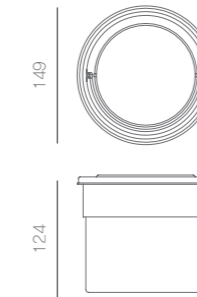

Embedded Type
D1-GGST-M

Door Attach Type / D1-GGST-D





Simswing

With a die-casting hinge installed on the side plate, weight load is reduced on the door. The design also allows for it to rotate as you open the door to ensure convenience and ease of use. Baskets may be removed to make it easy to store kitchen detergents and to clean.

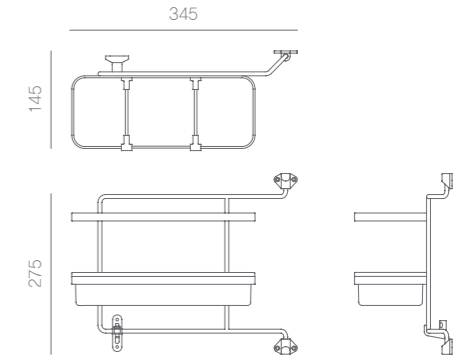

D1-PAS

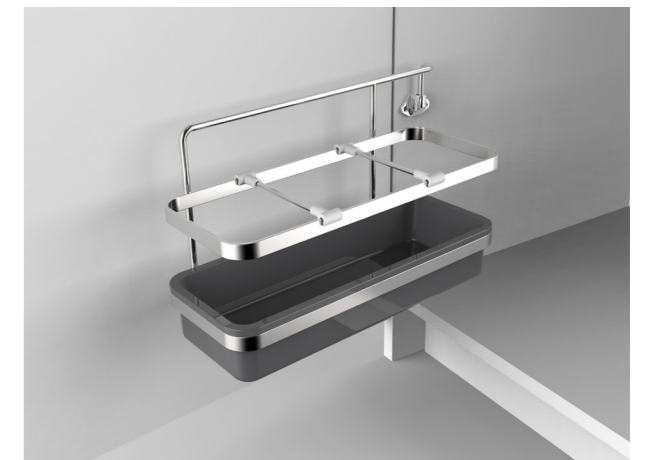

Elite Dish Drying Rack



D1-DEL / Non-standard Production Available

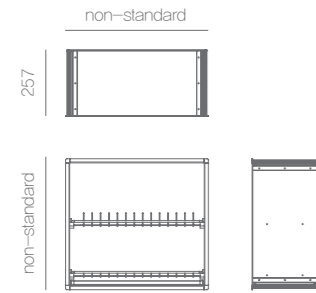

Corner Swing Shelf



D1-PSC / 400, 450, 500 Compatible

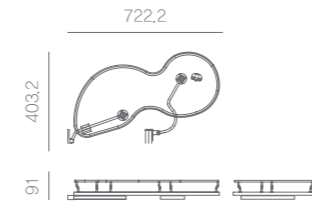

Magazine Holder

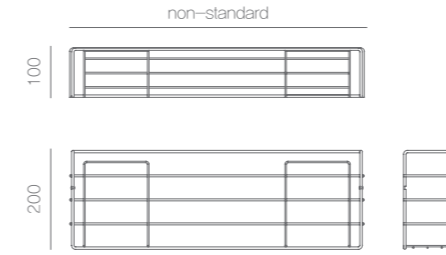

D1-BJG-500 / Non-standard Production Available



Loofah Rest

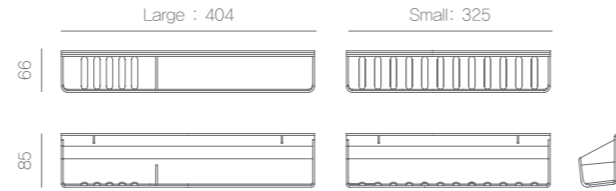

D1-GJPS-12

Bowl Shelf

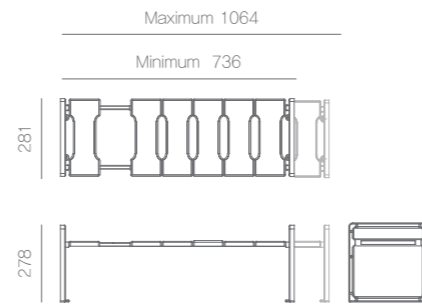

D2-PSH

Loony Rice Scoop Hanger

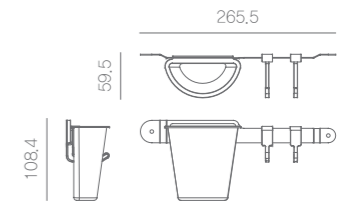

D1-GJLJ

Ladle Hanger

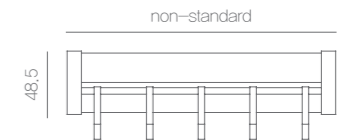

For Profile / D1-GIGJ-S

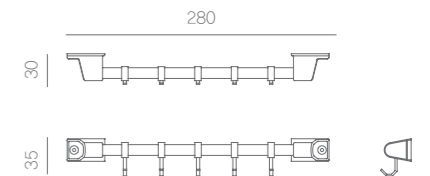

For Hanger / D1-GIGJ-H



New Partition ACC (4 items)

This is a partition designed to prevent water from splashing out of a sink bowl in a face-to-face type kitchen. Also, due to the absence of the rear shelf, which is inherent in face-to-face kitchens, a variety of shelves, including spoon containers, cup holders, and dish holders are installed using brackets on the partition edge to promote convenience and ease of use.



Glass Partition



Single Layer Shelf / D1-ANPA-1M

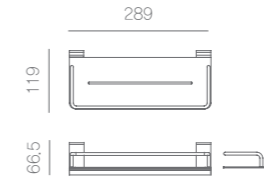

3-Cup Spoon Container / D1-ANPA-3S

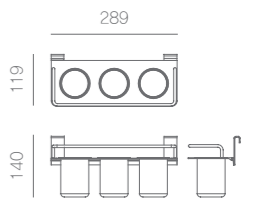

Basket Shelf반 / D1-ANPA-B

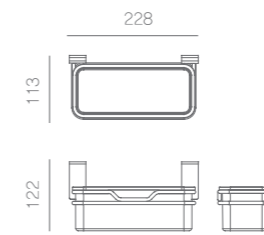

Cutting board holder / D1-ANPA-DM

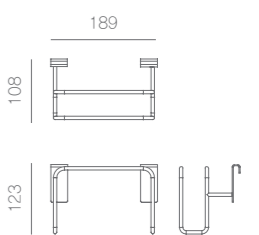

New Olian ACC (5 items)

Designed to be installed on the kitchen wall, this product is designed to connect with the rail. It is made of environmentally friendly stainless steel and aluminum and comes in various models. This product boasts of its superior design characterized by the curved wires and excellent practicality and accommodates a variety of cooking utensils, tableware and cutting boards. The product is comprised of five items, including one-level shelf, a three-hole spoon holder, basket shelf, wire shelf and cutting board rest.

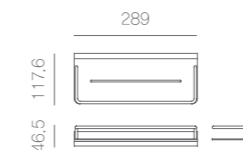

Single Layer Shelf / D1-ANLN-1M

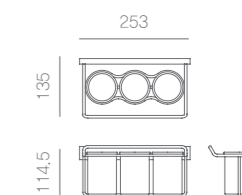

3-Cup Spoon Container / D1-ANLN-S3

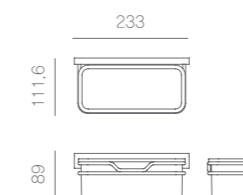

Basket Shelf / D1-ANLN-B

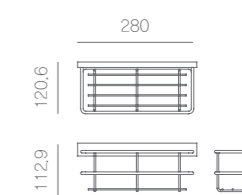

Wire Shelf / D1-ANLN-WS

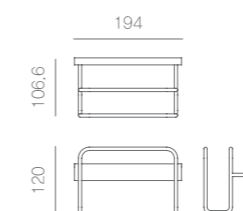

Cutting board holder / D1-ANLN-DM



Counter-top Canal ACC

This product allows a variety of items to be embedded in the rear kitchen shelf, including drying racks, spoon containers, dispensers, outlets, all-purpose containers, and dish holders, or a combination depending on the width of the kitchen top. With the addition of an optional damping function, you may eliminate hassling noise.

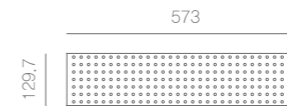
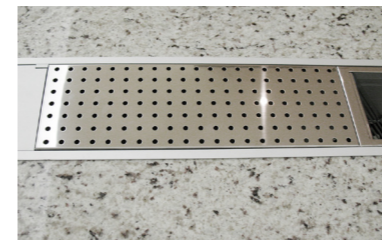

Drying rack / D1-PSD-G

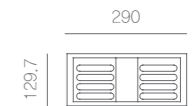
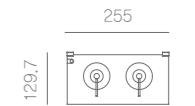

Plate Drying rack / D1-PSD-J



Storage compartment / D1-PSD-S



Dispenser / D1-PSD-D



Condiment stand / D1-PSD-Y

Hanger Rod



D1-UWG

Sink Bowl Cutting Board Holder

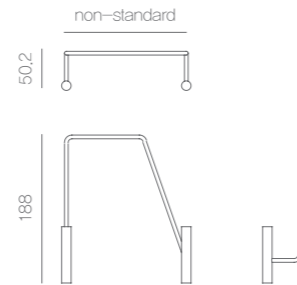

D1-GJDG

Magnetic Board

The magnetic board is one of the functional products that has surged in supply and demand in recent years in a bid to promote everyday life convenience. This product allows you to create an art wall in your kitchen area where you may attach several magnetic hooks to hold a variety of kitchen items and ornaments such as kitchen towels, gloves and bottle openers in a stylish manner.

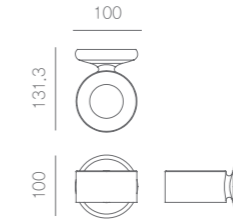

Vase / D1-GJMD-H

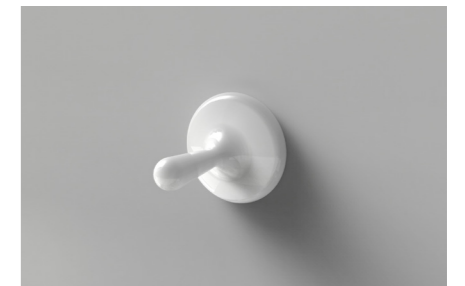
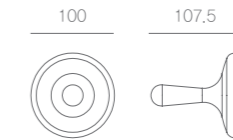

Drop Hanger / D1-GJMD-M

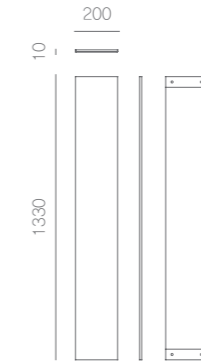

Steel Board / D1-GJMD

Kitchen Ladder

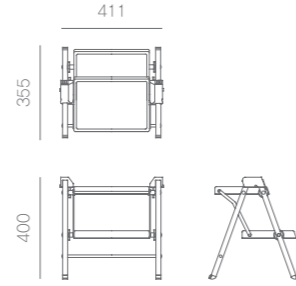

Original model / D1-GGJS

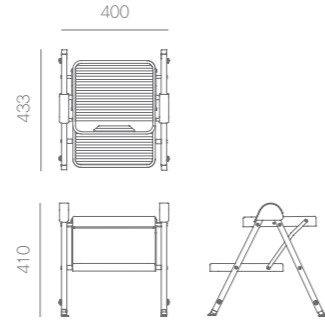

New model / D1-GGNJS
* Size when unfolded: 530

Wagon Chair



D1-GJYG

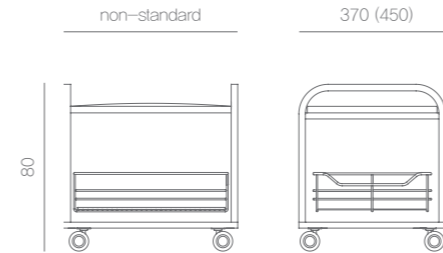

Injection Type Table Legs



D1-GIST

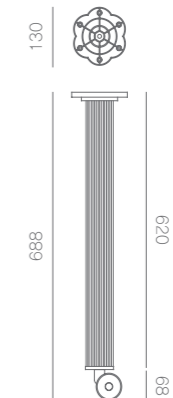

Rice Cooker Hood

This product is designed to prevent damage being inflicted on the wooden cabinet by water vapor generated from rice cookers. It automatically detects the presence of water and temperature to activate/deactivate the hood and is equipped with LED lighting for convenience of use. It comes in silver, yellow and black that match pretty much any kitchen furniture color.

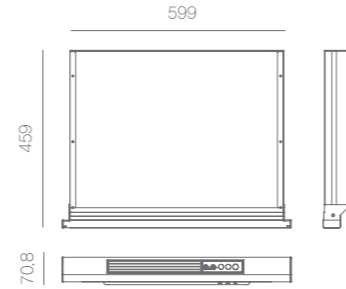

D1-GGBH



Design & Convenience



Ultra-slim and simple design sleek color Sleek color



Rear FAN cover case



Built-in internal LED

Efficiency



Rear outlet FAN Cross Flow FAN



Automatic temperature/humidity detecting sensors

Category		Description	
Function	Humidity sensor	Automatically makes a response if the internal humidity goes beyond the setting humidity inside the rack. Suspends in two minutes of operation (resumes operation in the presence of setting humidity)	Suspends in two minutes of operation (resumes operation unless the setting temperature comes down)
	Temperature sensor	① Automatically makes a response if the internal temperature goes beyond the setting temperature inside the rack ② In the event of radical temperature change inside the rack	Suspends in two minutes of operation (resumes operation unless the setting temperature comes down)
	Front CROSS FAN	Cross Flow FAN features slim design and excellent ventilation	
	Rear FAN (waterproof)	Pushes humidity left in the rear to the front to eliminate internal humidity fast	
Type	Built-in	Exposed	
Color	Earthy Yellow / Silver / Black		
Power	Voltage	AC 200V / 60Hz	
	Power Consumption (WH/h)	5w while on standby / 12w while in operation	
Dimension (W x D x H)		569 x 434 x 60	600 x 434 x 60
Weight (Kg)		3.9 Kg	

Underlay

This is a construction material which conforms to the eco-friendly housing policy and allows for the upper plate to be installed without removing the side plates on the bottom shelf with the adoption of a C channel. As a certified subsidiary material with a successful completion of tests, it is designed to support the excessive weight of the upper plate.



D1-GJUR-450

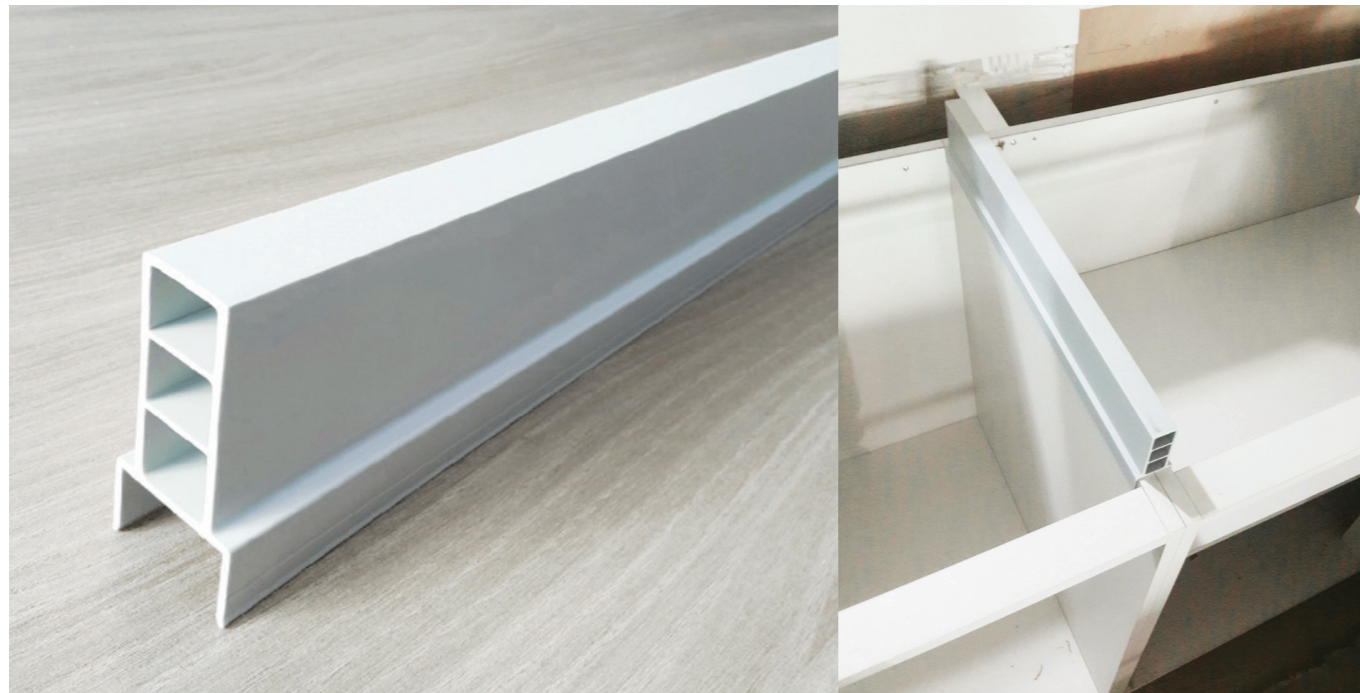

Ventilation Grill



D1-GING



Cutting Board

With its curved edge, this cutting board is well-suited to be used on the sink bowl. The embossed finish on its surface is designed to minimize slippage.



D1-GJDM



Wire Shelf

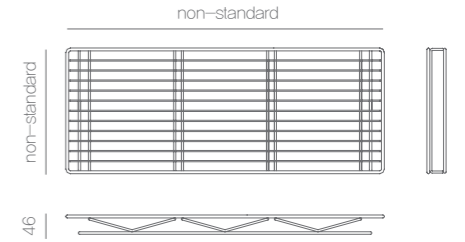

D1-PKI



* Not including the wine rack

General Furniture

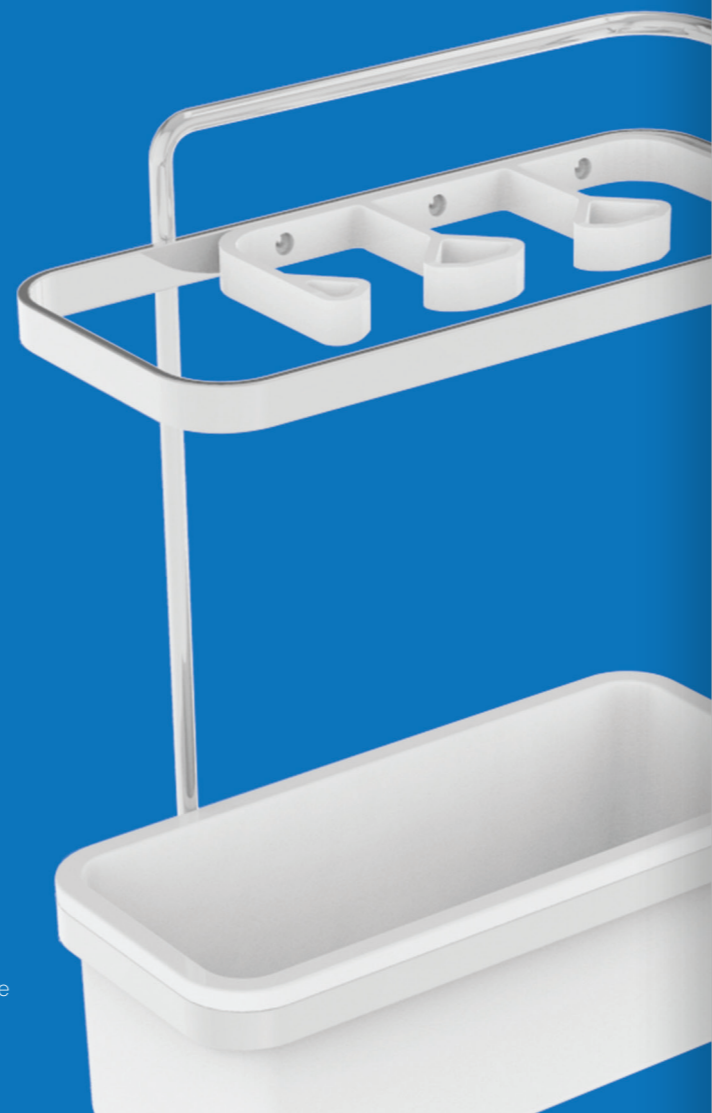

Entrance Closet

Umbrella Rack	96–101
Umbrella Hook	102–105
Umbrella Water Tray	106–107
Storage Hardware	108–109
Rack	110–114
Others	115–117

Wardrobe Closet

Mirror	118–119
Tie Hanger	120–121
Codi Hanger	122–123
Baskets	124–127
Others	128–131

Other Closet

Functional Hardware	132–135
Other Closet Accessories	136–139
Others	140–141

* The images in the catalog may be different from the actual products in terms of color and texture

Aeuri Umbrella Rack

The products come in a simple and modern design and are classified into three different categories (A, B, and C) depending on the purpose and use. It can be installed on the side of a built-in shoe rack or the back of the door. Type B products come with a bracket so that you can easily detach it on an as-needed basis such as when checking the electric distribution box at its back. You may also place it in a small-depth built-in shoe rack to maximize space utilization.

- Wire
- Basket

A TYPE + B TYPE



B TYPE + C TYPE



A TYPE + C TYPE



A TYPE
D1-UEW-A

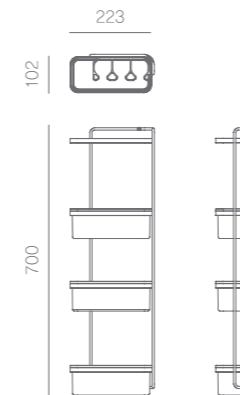

B TYPE
D1-UEW-B

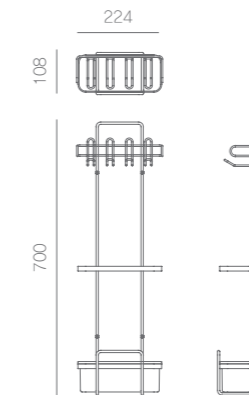

C TYPE
D1-UEW-C

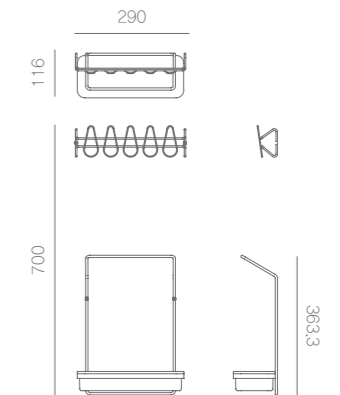

Cage Umbrella Rack

This product is designed to maximize storage efficiency by properly arranging wires and the injection basket. It is convenient to keep full and half-sized umbrellas in injection basket and to store a variety of accessories as well.

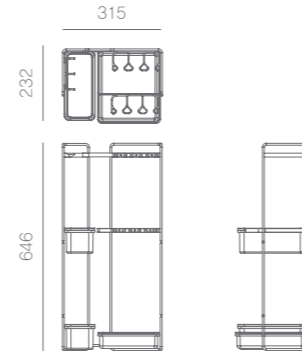

D1-UKG

Trimmer Umbrella Rack

It comes in a modern design with a powdercoated wire frame. It can accommodate small household items, including umbrellas, and its embedded holder makes it easier to keep a large number of umbrellas in a relatively small space.

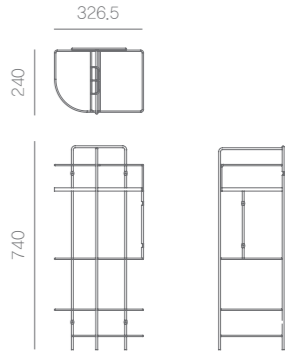

D1-UTL



Square Umbrella Rack

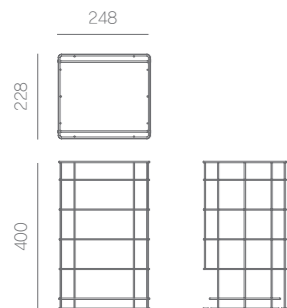

D1-USA



Fly Umbrella Rack

It comes in a modern design with a powder-coated wire frame. You may install it on the rear side of builtin shoe rack doors if the space of the built-in shoe rack is small. It can accommodate both full and half-sized umbrellas. The water tray can be split by a wire divider to prevent full-sized umbrellas from shaking when opening and closing the door.

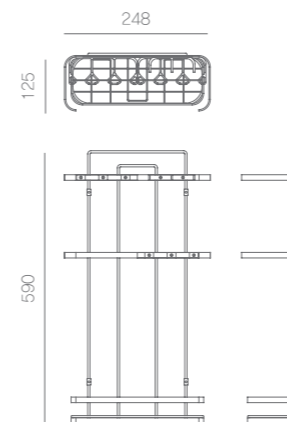

D1-UPL



Umbrella Hanging Rod



D1-UWG



Umbrella Guide

The product comes in a very simple design and allows you to easily store full-sized umbrellas as well as half-sized ones on hooks. Its minimalist design comes at an affordable price, which makes it ideal for small houses or rental apartments.

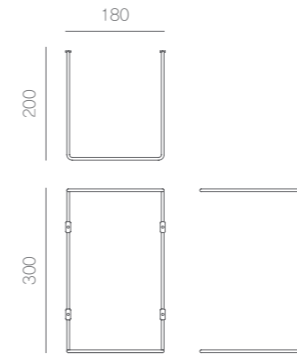

D1-UGD



Umbrella Hook



Umbrella Hook (plated) / D1-UHK-5D

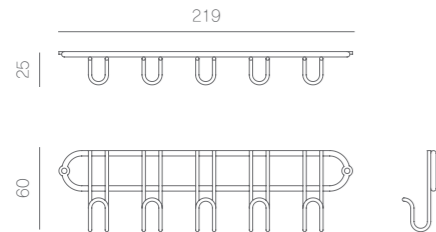

Umbrella Hook (coated) / D1-UHK-4B

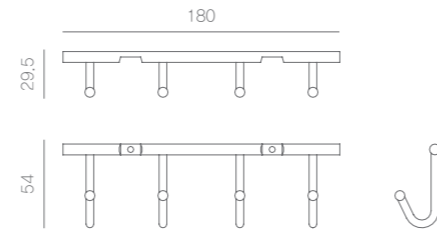

Hang & Hook



It comes in a water drop design unlike the conventional uniform wire hook products, minimizing the overall impression. Equipped with a plastic basket, it features multifunctions that include storage boxes as well as hooks.

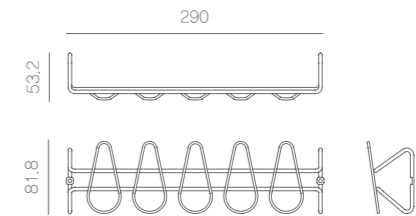

D1-UHU

Loony Hook

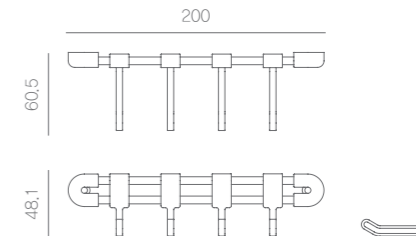

D1-ULH

Umbrella Water Tray



Umbrella Water Tray (Oval) / D1-UMB-T

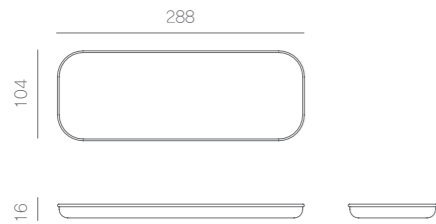

Umbrella Water Tray (Square) / D1-UMB-N

* Size of die cutting: 185 x 205mm

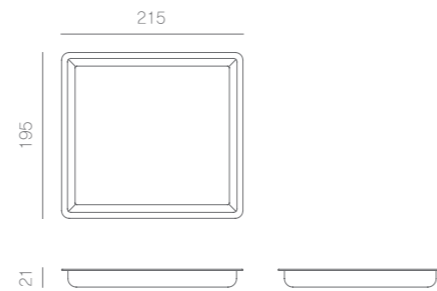

Max Water Tray

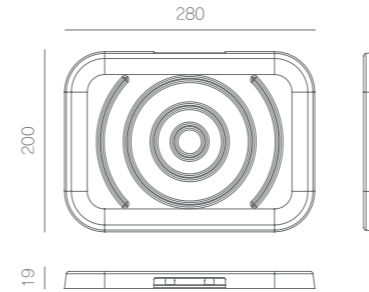

D1-UMB-S



Slippers Rack

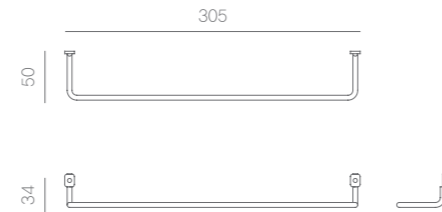

D1-GISG

Bat-Rack

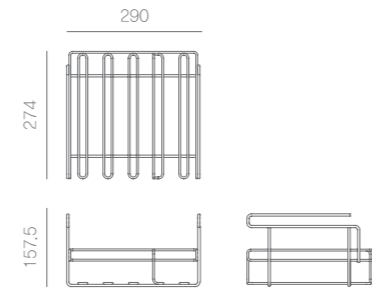

D1-PBG

Open Type Shelf Rack

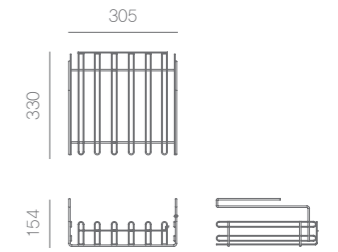

Guide Type / D1-PNS-G

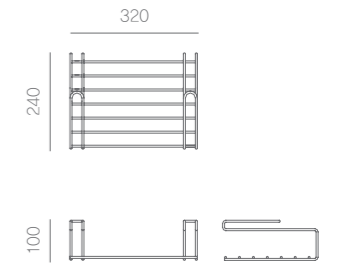

Open Type / D1-PNS-O

Folding Shoe Rack

Designed to be installed in a shoe rack, it is intended to facilitate the storage of long or high boots as the rack is conveniently foldable.

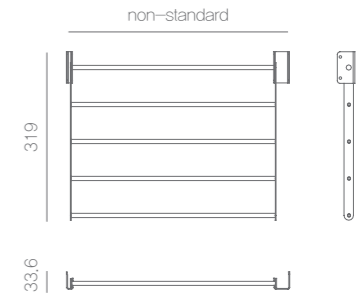

D1-GIPS



Tidy Rack

This product allows you to store various accessories in built-in shoe racks (entrance hall) with optional height adjustment available for some products. It is also equipped with injection hooks on top to allow you to handle a variety of items, including half-sized umbrellas, emergency flashlights, and accessories.

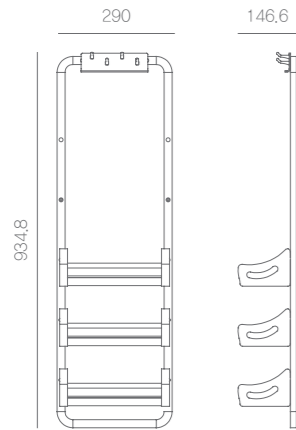

D1-UTR



Danny Vacuum Rack

It comes in a modern design with a powder-coated wire frame. It is designed to be installed on the side of built-in shoe racks to store a vacuum cleaner and its suction hose. It is equipped with an allpurpose basket on top to store various cleaner consumables and parts.

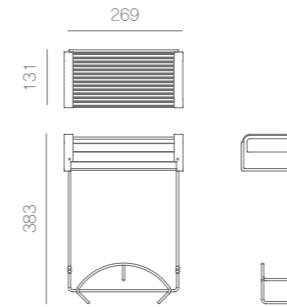

D1-UDC



Popular Vacuum Rack

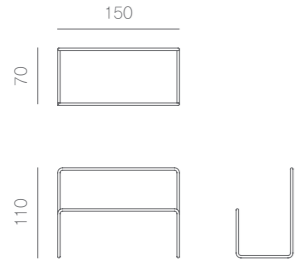

D1-GICR



Cabinet Shoe Stool

This product is designed to be installed on the bottom of a shoe rack as a built-in component. You may pull it out and use it as a chair when putting on or cleaning your shoes. There is also a small basket under the chair for storing small items.

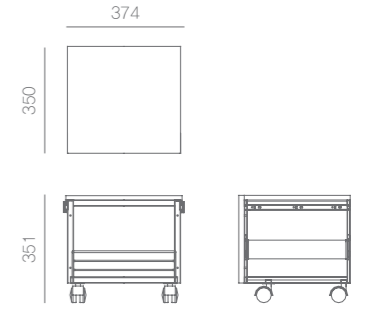

D1-GISS



Dual Ventilation Cap

This is a ventilation cap to promote air circulation inside built-in wardrobes and shoe racks. It comes with the dual type function of implementing both ventilation and deodorization. It is also equipped with a detachable cover, which makes it easy to replace deodorants.

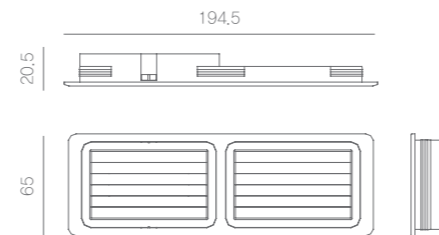

D1-KDU



Deodorization Grill

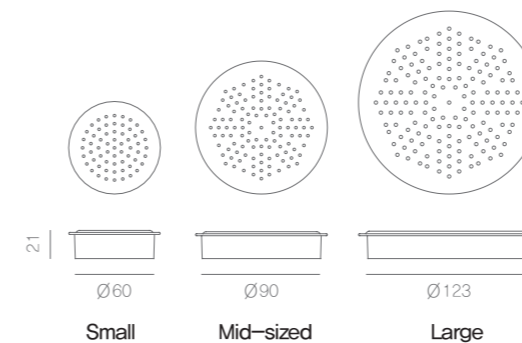

D1-KSG





DR.M (Door Mirror)

This is an attachable mirror that can be installed on the inner side of a door. The storage rack and the hanger are combined in one piece for user convenience and the overall modern and aesthetic line is appealing to consumers.

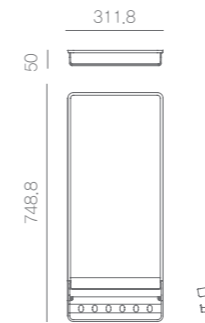

D1-GIDR



Aetie Tie Hanger



This product is attached to the back of built-in cabinet (support cabinet) doors and is ideal for hanging a lot of ties. In addition, the high-grade tie hanger allows you to store various ornaments, including tie pins, further enhancing the convenience of storage.

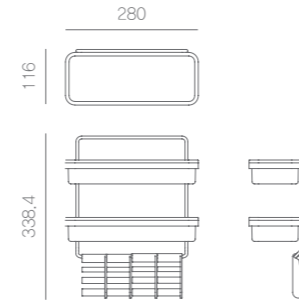

D1-GIET

Triple Wire Tie Hanger

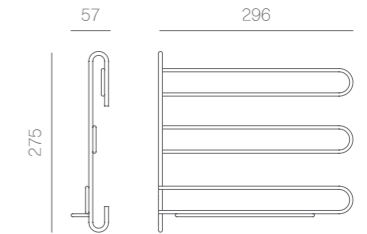

D2-GITG-W

Combi/Slim Tie Hanger

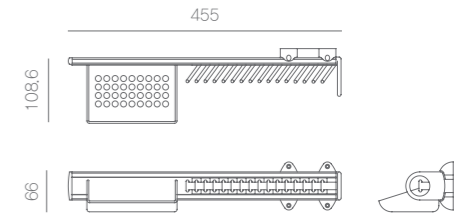

Combi-Tie Hanger / D1-GITG-SU

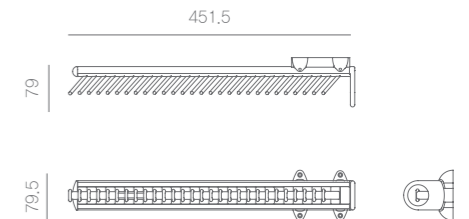

Slim Tie Hanger / D1-GITG-SM

Codi Hanger

Slim Codi Hanger / D1-GICG-S

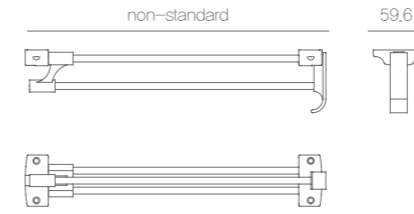

Double Codi Hanger
D1-GICG-D

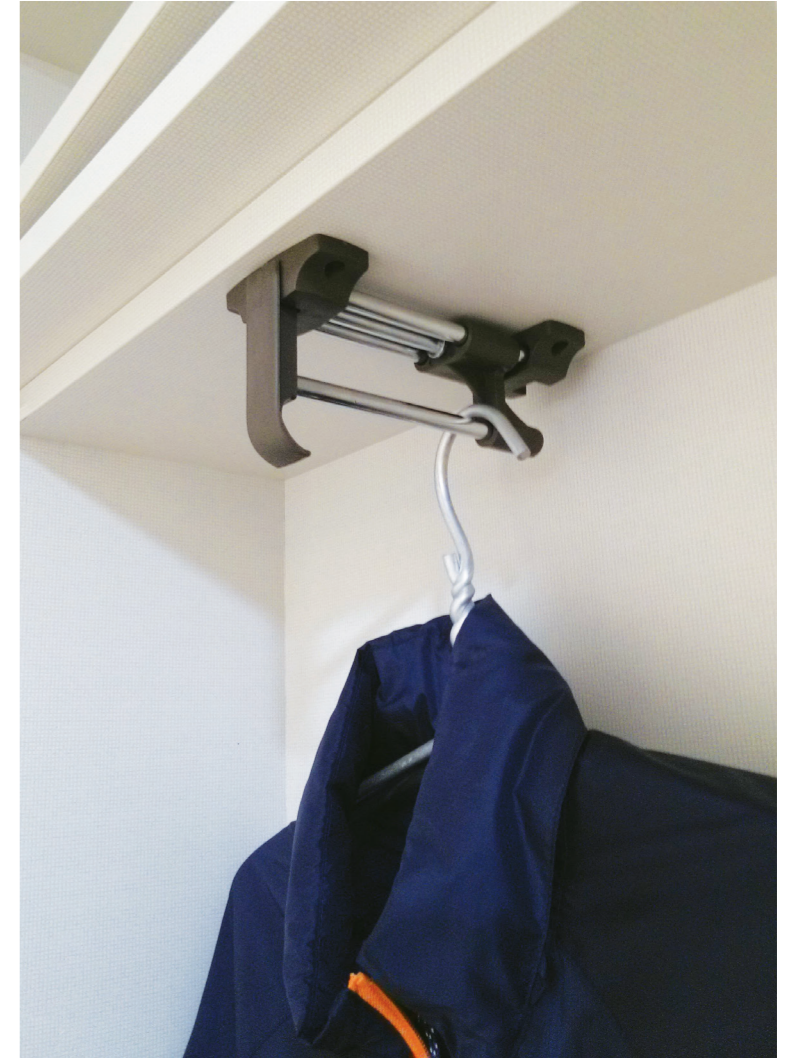

Big Closet Storage Basket

This large basket with a modern design is ideal for storing large sized clothes in bulk. It features excellent usability at a competitive price and is widely adopted and used in auxiliary kitchens or in open racks of apartments. In particular, the rattan pattern on the front and the other pattern on the back can be replaced according to preference. Also, the stopper function when drawing the basket ensures user safety.

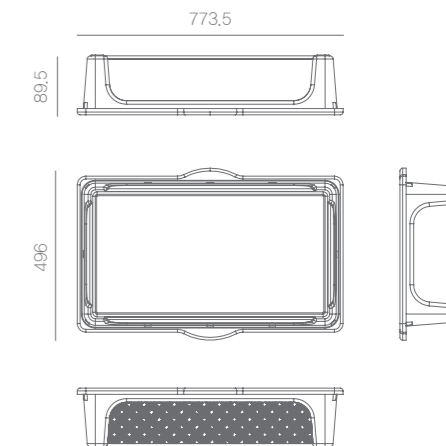

D1-GIBB



PVC Storage Box

This product is designed to enable the removal of baskets by installing rails on both sides of a storage cabinet. It is detachable as well. The stopper prevents the basket from being completely removed when opening horizontally to ensure safety. In addition, the basket products come in various colors and sizes, including large, medium, and small, which allow you to store various items in a hygienic and convenient manner.

D2-BKI

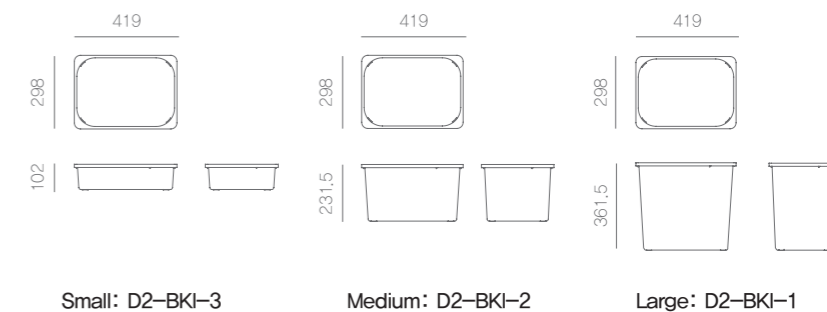

Dressing Table Divider

Acrylic

This product is installed in the dressing table drawer to store various accessories in different storage sections. Being made of acrylic, it features adjustable sections and a simple design.

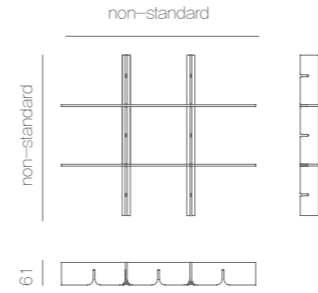

Acrylic: D1-SHD-AC



Aluminum

Designed to be installed in a dressing table drawer, the product is used to store various accessories in different storage sections. The movable dividers promote convenience while the aluminum finish adds an extra touch of luxury.

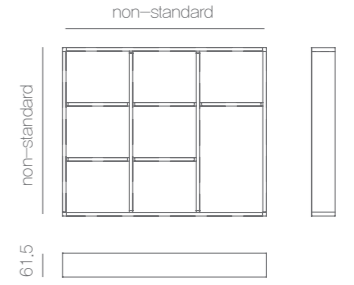

Aluminum: D1-SHD-AL



Tissue Holder

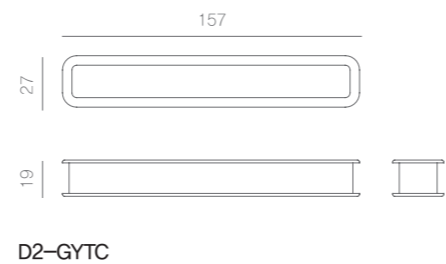

Shelf Divider

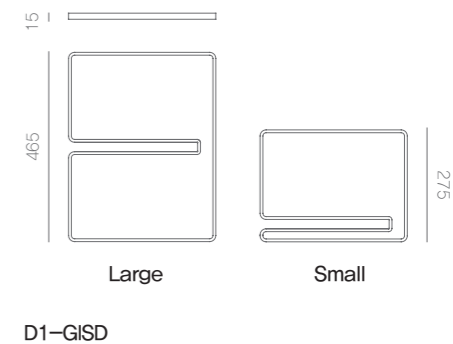

Cleaning System Rack

Designed to be installed in the entrance or shoe rack, it is used to conveniently store a variety of cleaning equipment and household items. The rack is conveniently movable from one location to another.

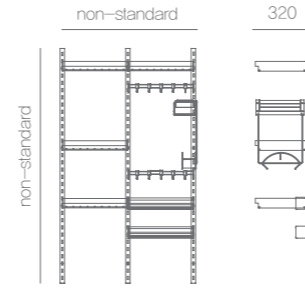

D1-GIBS



Sports System Rack

Designed to be installed in the entrance rack or shoe rack, it is used to conveniently store a variety of sports equipment and household items. The rack is conveniently movable from one location to another.

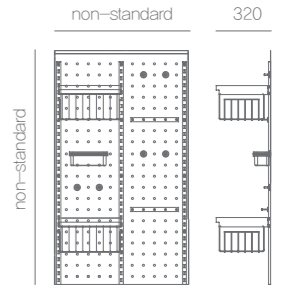

D1-GIUS

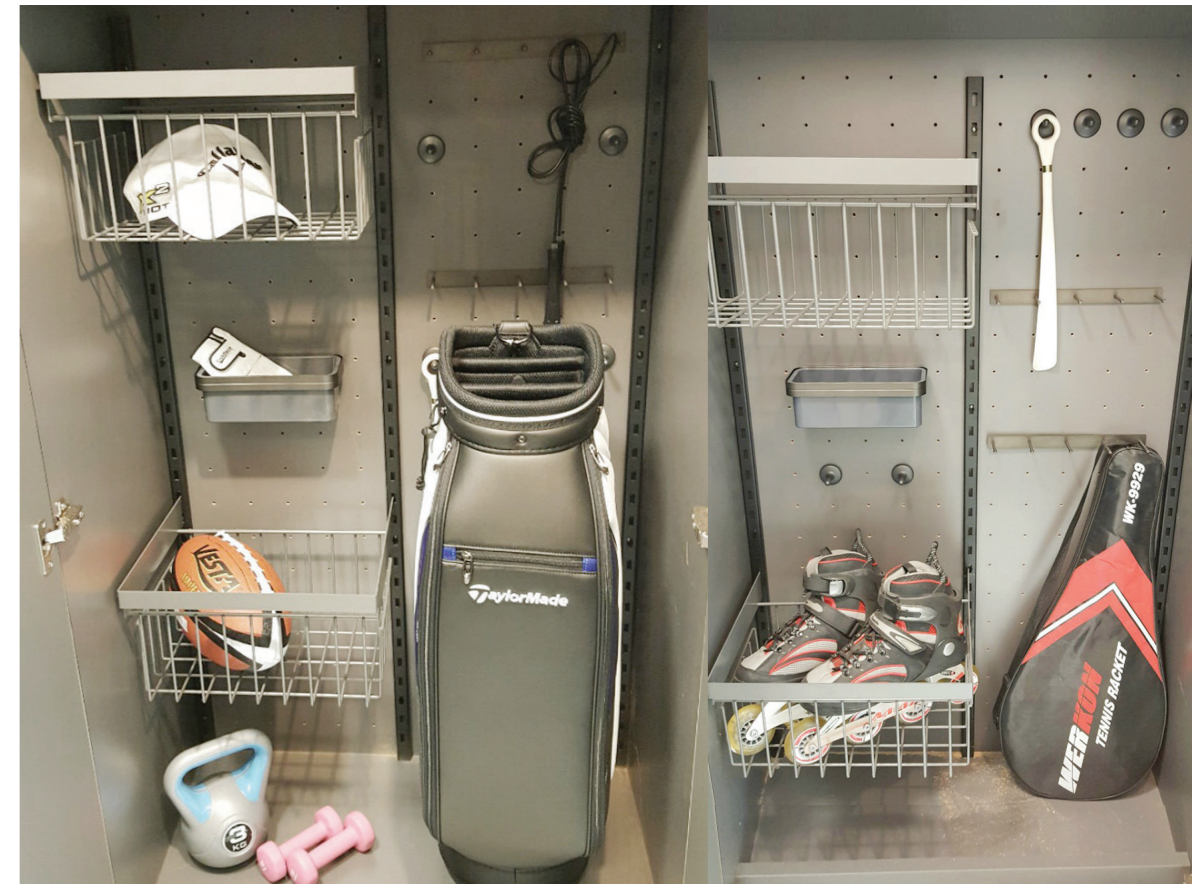

Medicine/Emergency Storage

This is a first-aid kit container made of steel and is designed to be installed in a shoe rack and/or on a shelf. You may also store a variety of small personal belongings in addition to medicines. This product can be custommade to meet your specific needs.

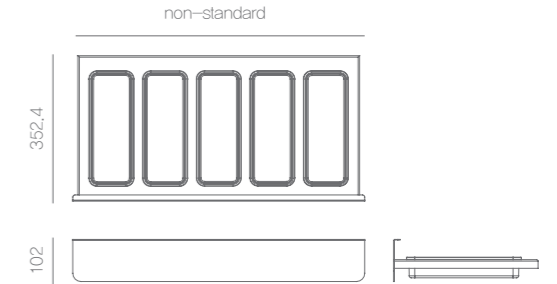

D1-GGYB





Wall Panel ACC (9 items)



Single Layer Shelf / D1-AWA-M1

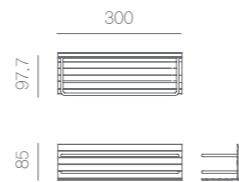

3-Cup Spoon Container / D1-AWA-S3

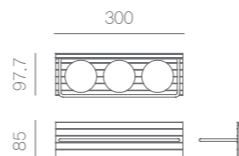

Slippers Hanger / D1-AWA-MP

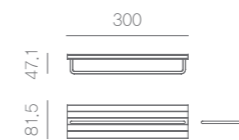

Double Hook Hanger / D1-AWA-MD2

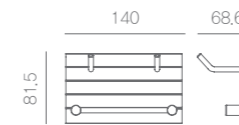

Wire shelf / D1-AWA-WS

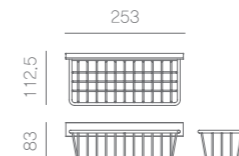

Racket Hanger / D1-AWA-MK

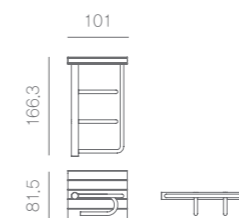

Towel Hanger / D1-AWA-MT

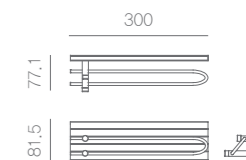

Wrap Hanger / D1-AWA-ML

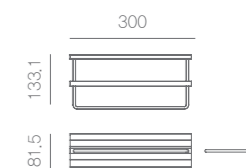

Dustpan Rest / D1-AWA-MS

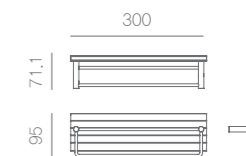



New Wall Panel ACC (5 items)

This product features excellent space utilization and is designed to be installed in tight spaces that are not sufficient enough to allow the installation of a cabinet, or as a versatile side wall on a veranda. You may have accessories of your choice fitted to the profile depending on your needs.

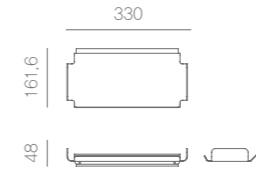

Single Layer Shelf / D1-ALWA-M1

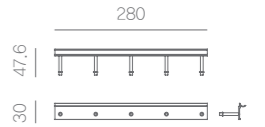

Versatile Hook / D1-ALWA-D5

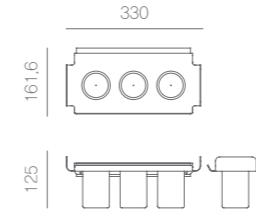

3-Cup Spoon Container / D1-ALWA-S3

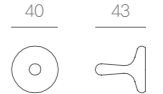
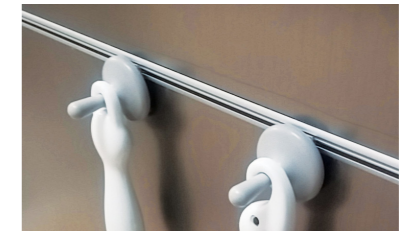

Water Drop Hook / D1-ALWA-H

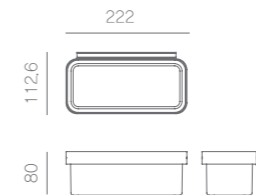

Basket Shelf / D1-ALWA-F

Lift-up Table

This hardware product is designed to be installed on a coffee table. Its top plate is vertically movable to provide users with extra convenience especially while having a meal or using a laptop. It also features easy installation as well.

D2-GILT ○ ●

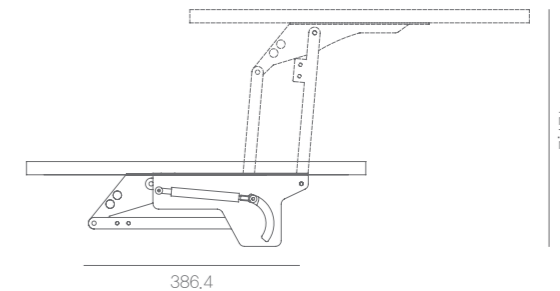

Office Furniture



Lighting	144–147
CPU Holder & Wagon	148–149
Desk Legs	150
Book End	150
Outlet Duct	151
Under the Desk Duck	152
Monitor Lift	152
Hamper Cart	153
Pocket Compartment	153

* The images in the catalog may be different from the actual products in terms of color and texture



Smart Lighting

This is designed as a desk lamp and features several versatile functions making it popular among students. The brightness and light angle are adjustable and it comes with a Bluetooth function so that users can use it as a speaker and for telephone conversation by pairing it with their mobile devices.

Rated Voltage	DC 12V /1A, DC5V /2A
Power Consumption	30W (max)
Lamp Spec.	0.5W LED 56EA
Color Temperature	3000~6500K
Brightness	400~100Lux (based on the installation height of 490mm)
LED Lifespan	40,000 hours or longer
Dimension (mm)	W1160 X D68 X H35
Composition	main body, adapter, user's manual, bracket, piece, line arranging hook
Main body	Aluminum / ABS
Control Button	Touch switch / Blue led
Lamp Cover	Optical diffusion acryl



D1-LSM-1000LSL



Desk Lighting



D1-LIP-1000LS

Book Holder Lighting



D2-LDS-600T

Stand Lighting

This lighting equipment is designed to be used in a library or study room. It is particularly suitable for students as it disperses light in an even manner. It features extra softness with its curved design.

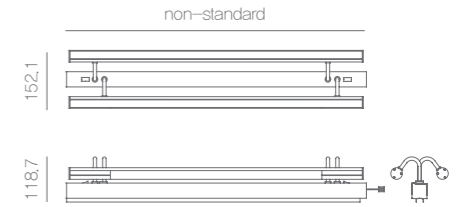

D1-LYD



CPU Holder



Single Type / D3-PCH-1

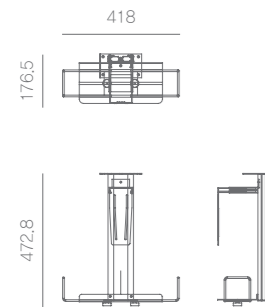

Couple Type / D3-PCH-2

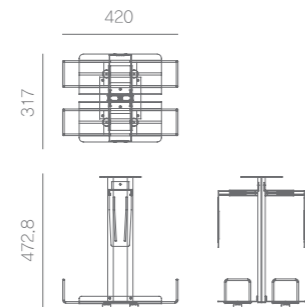

Rotating Type / D3-PCH-3

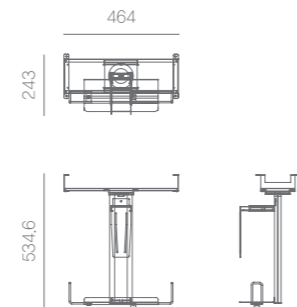

CPU Wagon



D2-PCW / 300 Compatible

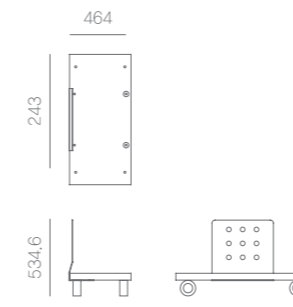

Desk Legs



D2-GICD



Book End



D2-GIBO

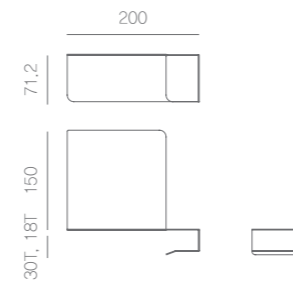

Outlet Duct

This product helps neatly arrange various cables from beam projectors, notebooks, etc., and is equipped with an indicator light for extra convenience making it ideal for organizing cables underneath conference tables. It comes in a variety of standards, shapes, and colors, and customized orders are available.

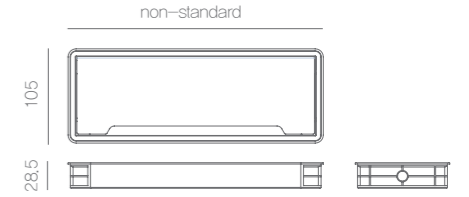

D1-CDC



Under the Desk Duct

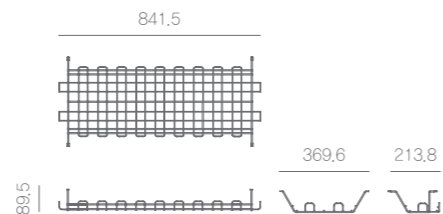

D3-GSBH

Monitor Lift

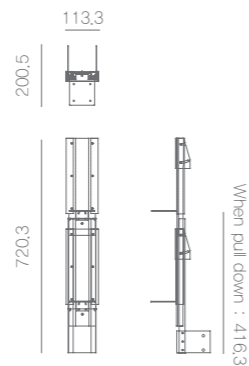

D1-GGML

Hamper Cart



D1-GIHK

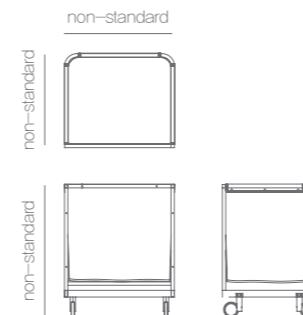

Pocket Compartment



D3-GSPS

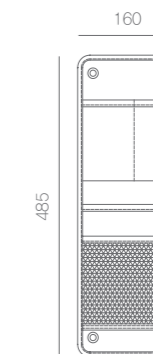

Bathroom Furniture



* The images in the catalog may be different from the actual products in terms of color and texture

Bathroom Basket	156
Wire Holder	157
Dryer Holder	157

Bathroom Basket

This is a wire basket designed to be placed in a mirror rack in the bathroom and to conveniently store small items. It is easily customizable due to its simple manufacturing process and is made of rust-free stainless steel.

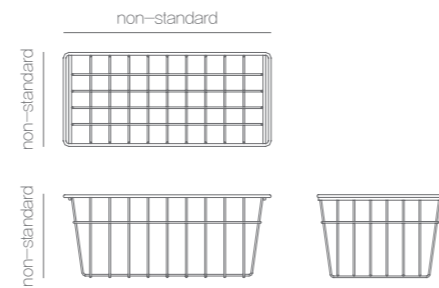

D4-GYYB



Wire Holder



D2-GYJC

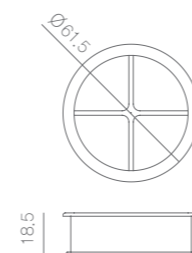

Dryer Holder



D4-BDB

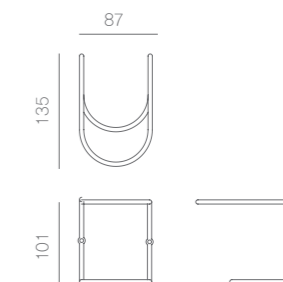

D & N E W

DESIGNING NEW
KITCHEN SYSTEM & FURNITURE



D&NEW is your trusted partner household furniture accessories manufacturer.

We specialize in designing and manufacturing a variety of household hardware accessories associated with kitchen furniture, general furniture, office furniture, and architectural interior design.

NEW Kitchen & Furniture Accessory Collections
"Life is about everyday"



www.dnnew.co.kr

D&NEW Co., Ltd.
464-882
694-43, Docheok-ro
Docheok-myeon, Gwangju-si
Gyeonggi-do, Korea

TEL. +82 31 798 4740
FAX. +82 70 4325 7077